



User Manual

Wireless N600 Dual Band Gigabit Cloud Router

DIR-826L

Preface

D-Link reserves the right to revise this publication and to make changes in the content hereof without obligation to notify any person or organization of such revisions or changes.

Manual Revisions

Revision	Date	Description
1.0	February 27, 2012	• Initial release for Revision A1

Trademarks

D-Link and the D-Link logo are trademarks or registered trademarks of D-Link Corporation or its subsidiaries in the United States or other countries. All other company or product names mentioned herein are trademarks or registered trademarks of their respective companies.

Copyright © 2012 by D-Link Systems, Inc.

All rights reserved. This publication may not be reproduced, in whole or in part, without prior expressed written permission from D-Link Systems, Inc.

Table of Contents

Preface	i	PPPoE (DSL)	31
Manual Revisions	i	PPTP	33
Trademarks	i	L2TP	35
Product Overview	1	DS-Lite	37
Package Contents	1	Wireless Settings	38
System Requirements	2	Manual Wireless Settings	39
Introduction	3	802.11n/g (2.4GHz)	39
Features	4	802.11n/a (5GHz)	40
Hardware Overview	5	Wireless Security	41
Connections	5	What is WPA?	41
LEDs	6	Wireless Security Setup Wizard	42
Installation	7	Add Wireless Device with WPS Wizard	44
Before you Begin	7	WPA/WPA2-Personal (PSK)	46
Wireless Installation Considerations	8	Configure WPA/WPA2-Enterprise (RADIUS)	47
Manual Setup	9	Network Settings	49
Connect to an Existing Router	11	Router Settings	49
Configuration	13	DHCP Server Settings	50
Quick Setup Wizard	14	DHCP Reservation	52
QRS Mobile App	21	Storage	53
SharePort Mobile App	22	Access Files from the Internet	54
Web-based Configuration Utility	26	IPv6	55
Internet Connection Setup	27	IPv6 Internet Connection Setup Wizard	56
Static (assigned by ISP)	28	IPv6 Manual Setup	61
Dynamic (Cable)	30	mydlink Settings	70
		Advanced	71
		Virtual Server	71

Port Forwarding	72	Statistics	102
Application Rules	73	Internet Sessions.....	103
QoS Engine.....	74	Routing	104
Network Filters.....	75	Wireless.....	105
Access Control.....	76	IPv6	106
Website Filters.....	79	IPV6 Routing	107
Inbound Filters.....	80	Support	108
Firewall Settings.....	81	Connect a Wireless Client to your Router	109
Routing	83	WPS Button.....	109
Advanced Wireless	84	Windows® 7.....	110
Wi-Fi Protected Setup (WPS)	85	WPA/WPA2	110
Advanced Network Settings.....	87	WPS.....	113
Guest Zone	88	Windows Vista®	117
IPv6 Firewall	89	WPA/WPA2	118
IPv6 Routing	90	WPS/WCN 2.0	120
Tools	91	Windows® XP	121
Admin.....	91	WPA/WPA2	122
Time	92	Troubleshooting	124
SysLog.....	93	Wireless Basics	128
Email Settings.....	94	What is Wireless?.....	129
System	95	Tips.....	131
Firmware	96	Wireless Modes.....	132
Language Pack.....	96	Networking Basics	133
Dynamic DNS	97	Check your IP address.....	133
System Check.....	98	Statically Assign an IP address	134
Schedules	99	Technical Specifications	135
Status	100		
Device Info	100		
Logs.....	101		

Package Contents



DIR-826L Wireless N600 Dual Band Gigabit Cloud Router

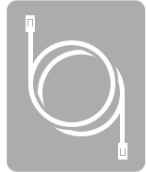

Ethernet Cable



Power Adapter



WI-FI Configuration Note

If any of the above items are missing, please contact your reseller.

Note: Using a power supply with a different voltage rating than the one included with the DIR-826L will cause damage and void the warranty for this product.

System Requirements

<p>Network Requirements</p>	<ul style="list-style-type: none"> • An Ethernet-based Cable or DSL modem • IEEE 802.11n or 802.11g wireless clients • 10/100/1000 Ethernet
<p>Web-based Configuration Utility Requirements</p>	<p>Computer with the following:</p> <ul style="list-style-type: none"> • Windows®, Macintosh, or Linux-based operating system • An installed Ethernet adapter <p>Browser Requirements:</p> <ul style="list-style-type: none"> • Internet Explorer 7 or higher • Firefox 3.5 or higher • Safari 4 or higher • Chrome 8 or higher <p>Windows® Users: Make sure you have the latest version of Java installed. Visit www.java.com to download the latest version.</p>
<p>mydlink Requirements</p>	<ul style="list-style-type: none"> • iPhone/iPad/iPod Touch (iOS 3.0 or higher) • Android device (1.6 or higher) • Computer with the following browser requirements: <ul style="list-style-type: none"> • Internet Explorer 7 or higher • Firefox 3 or higher • Safari 5 or higher • Chrome 5 or higher <p><small>iPhone, iPad, and iPod touch are registered trademarks of Apple Inc. Android is a trademark of Google, Inc.</small></p>

Introduction

The D-Link Wireless N600 Dual Band Gigabit Cloud Router (DIR-826L) comes equipped with 4 Gigabit ports to provide speeds up to 10x faster than standard 10/100 ports. It also uses 802.11n technology with multiple intelligent antennas to maximize the speed and range of your wireless signal to significantly outperform 802.11g devices.

With the addition of Intelligent Quality of Service (QoS), data streams are separated which helps organize and prioritize your network traffic so your video streaming, gaming, and VoIP calls run smoother over both your wired and wireless network.

The D-Link Cloud Service will allow you to always have access to your home network no matter where you go. Now you can monitor and manage your home network right from your laptop, iPhone®, iPad®, or Android™ device. The cloud-enabled router can be configured to send an email to keep you informed anywhere, anytime when new devices are connecting to your network or unwanted access is detected. Monitor in real-time websites that are being visited with recent browser history displayed on the mydlink™ Lite app – which is great for parents.

The D-Link Cloud Service can detect and block unwelcomed guests who try to get into your wireless network and suspicious activities will be displayed right on your mydlink™ Lite app or browser.

Features

- **Faster Wireless Networking** - The DIR-826L provides up to 300Mbps* wireless connection with other 802.11n wireless clients. This capability allows users to participate in real-time activities online, such as video streaming, online gaming, and real-time audio. The performance of this 802.11n wireless router gives you the freedom of wireless networking at speeds 14x faster than 802.11g.
- **Compatible with 802.11a/g Devices** - The DIR-826L is still fully compatible with the IEEE 802.11g and 802.11a standards, so it can connect with existing 802.11g and 802.11a PCI, USB, and Cardbus adapters.
- **Advanced Firewall Features** - The Web-based user interface displays a number of advanced network management features including:
 - **Content Filtering** - Easily applied content filtering based on MAC Address, URL, and/or Domain Name.
 - **Filter Scheduling** - These filters can be scheduled to be active on certain days or for a duration of hours or minutes.
 - **Secure Multiple/Concurrent Sessions** - The DIR-826L can pass through VPN sessions. It supports multiple and concurrent IPSec and PPTP sessions, so users behind the DIR-826L can securely access corporate networks.
- **User-friendly Setup Wizard** - Through its easy-to-use Web-based user interface, the DIR-826L lets you control what information is accessible to those on the wireless network, whether from the Internet or from your company's server. Configure your router to your specific settings within minutes.

* Maximum wireless signal rate derived from IEEE Standard 802.11a, 802.11g and 802.11n specifications. Actual data throughput will vary. Network conditions and environmental factors, including volume of network traffic, building materials and construction, and network overhead, lower actual data throughput rate. Environmental conditions will adversely affect wireless signal range.

Hardware Overview

Connections

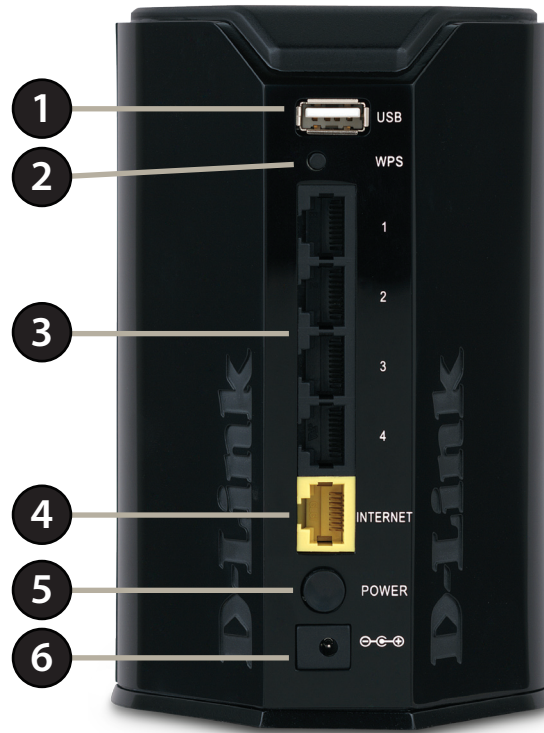

1	USB Port	Connect a USB flash drive to share content throughout your network.
2	WPS Button	Press to start the WPS process. The Internet LED will start to blink.
3	LAN Ports (1-4)	Connect 10/100/1000 Ethernet devices such as computers, switches, storage (NAS) devices and game consoles.
4	Internet Port	Using an Ethernet cable, connect your broadband modem to this port.
5	Power Button	Press the power button to power on and off.
6	Power Receptor	Receptor for the supplied power adapter.

Hardware Overview

LEDs



1	Power LED	A solid green light indicates a proper connection to the power supply. The light will blink green during the WPS process. The light will blink orange during boot up.
2	Internet LED	A solid light indicates connection on the Internet port. If the LED is orange, the connection is good but the router cannot connect to the Internet.

Installation

This section will walk you through the installation process. Placement of the router is very important. Do not place the router in an enclosed area such as a closet, cabinet, or in the attic or garage.

Before you Begin

- Please configure the router with the computer that was last connected directly to your modem.
- You can only use the Ethernet port on your modem. If you were using the USB connection before using the router, then you must turn off your modem, disconnect the USB cable and connect an Ethernet cable to the Internet port on the router, and then turn the modem back on. In some cases, you may need to call your ISP to change connection types (USB to Ethernet).
- If you have DSL and are connecting via PPPoE, make sure you disable or uninstall any PPPoE software such as WinPoet, Broadjump, or Enternet 300 from your computer or you will not be able to connect to the Internet.

Wireless Installation Considerations

The D-Link wireless router lets you access your network using a wireless connection from virtually anywhere within the operating range of your wireless network. Keep in mind, however, that the number, thickness and location of walls, ceilings, or other objects that the wireless signals must pass through, may limit the range. Typical ranges vary depending on the types of materials and background RF (radio frequency) noise in your home or business. The key to maximizing wireless range is to follow these basic guidelines:

1. Keep the number of walls and ceilings between the D-Link router and other network devices to a minimum - each wall or ceiling can reduce your adapter's range from 3-90 feet (1-30 meters.) Position your devices so that the number of walls or ceilings is minimized.
2. Be aware of the direct line between network devices. A wall that is 1.5 feet thick (.5 meters), at a 45-degree angle appears to be almost 3 feet (1 meter) thick. At a 2-degree angle it looks over 42 feet (14 meters) thick! Position devices so that the signal will travel straight through a wall or ceiling (instead of at an angle) for better reception.
3. Building Materials make a difference. A solid metal door or aluminum studs may have a negative effect on range. Try to position access points, wireless routers, and computers so that the signal passes through drywall or open doorways. Materials and objects such as glass, steel, metal, walls with insulation, water (fish tanks), mirrors, file cabinets, brick, and concrete will degrade your wireless signal.
4. Keep your product away (at least 3-6 feet or 1-2 meters) from electrical devices or appliances that generate RF noise.
5. If you are using 2.4GHz cordless phones or X-10 (wireless products such as ceiling fans, lights, and home security systems), your wireless connection may degrade dramatically or drop completely. Make sure your 2.4GHz phone base is as far away from your wireless devices as possible. The base transmits a signal even if the phone is not in use.

Manual Setup

1. Turn off and unplug your cable or DSL broadband modem. This is required.

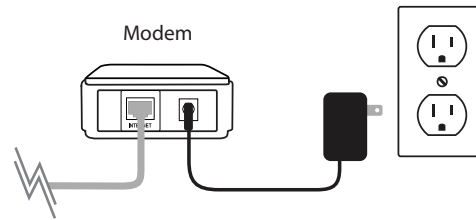

2. Position your router close to your modem and a computer. Place the router in an open area of your intended work area for better wireless coverage.
3. Unplug the Ethernet cable from your modem (or existing router if upgrading) that is connected to your computer. Plug it into the LAN port labeled **1** on the back of your router. The router is now connected to your computer.

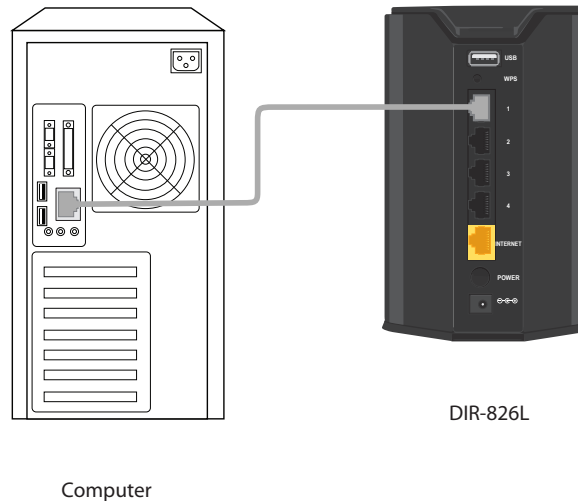

4. Plug one end of the included blue Ethernet cable that came with your router into the yellow port labeled INTERNET on the back of the router. Plug the other end of this cable into the Ethernet port on your modem.

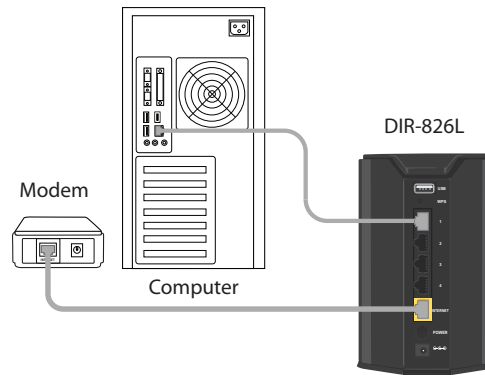

5. Reconnect the power adapter to your cable or DSL broadband modem and wait for two minutes.
6. Connect the supplied power adapter into the power port on the back of the router and then plug it into a power outlet or surge protector. Press the power button and verify that the power LED is lit. Allow 1 minute for the router to boot up.

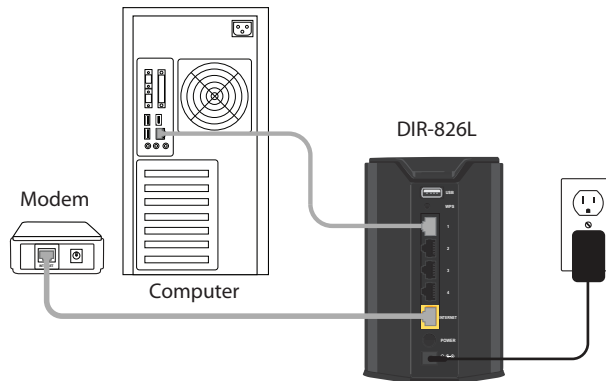

7. If you are connecting to a Broadband service that uses a dynamic connection (not PPPoE), you may be online already. Try opening a web browser and enter a web site. If you connect, you are finished with your Internet setup. Please skip to page 13 to configure your router and use the manual setup procedure to configure your network and wireless settings. If you did not connect to the Internet, use the D-Link Setup Wizard (refer to page 14).

Connect to an Existing Router

Note: *It is strongly recommended to replace your existing router with the DIR-826L instead of using both. If your modem is a combo router, you may want to contact your ISP or manufacturer's user guide to put the router into Bridge mode, which will 'turn off' the router (NAT) functions.*

If you are connecting the DIR-826L router to an existing router to use as a wireless access point and/or switch, you will have to do the following to the DIR-826L before connecting it to your network:

- Disable UPnP™
- Disable DHCP
- Change the LAN IP address to an available address on your network. The LAN ports on the router cannot accept a DHCP address from your other router.

To connect to another router, please follow the steps below:

1. Plug the power into the router. Connect one of your computers to the router (LAN port) using an Ethernet cable. Make sure your IP address on the computer is 192.168.0.xxx (where xxx is between 2 and 254). Please see the **Networking Basics** section for more information. If you need to change the settings, write down your existing settings before making any changes. In most cases, your computer should be set to receive an IP address automatically in which case you will not have to do anything to your computer.
2. Open a web browser, enter **http://192.168.0.1** and press **Enter**. When the login window appears, set the user name to **Admin** and leave the password box empty. Click **Log In** to continue.
3. Click on **Advanced** and then click **Advanced Network**. Uncheck the **Enable UPnP** checkbox. Click **Save Settings** to continue.
4. Click **Setup** and then click **Network Settings**. Uncheck the **Enable DHCP Server** checkbox. Click **Save Settings** to continue.

5. Under Router Settings, enter an available IP address and the subnet mask of your network. Click **Save Settings** to save your settings. Use this new IP address to access the configuration utility of the router in the future. Close the browser and change your computer's IP settings back to the original values as in Step 1.
6. Disconnect the Ethernet cable from the router and reconnect your computer to your network.
7. Connect an Ethernet cable in one of the **LAN** ports of the router and connect it to your other router. Do not plug anything into the Internet (WAN) port of the D-Link router.
8. You may now use the other 3 LAN ports to connect other Ethernet devices and computers. To configure your wireless network, open a web browser and enter the IP address you assigned to the router. Refer to the **Configuration** and **Wireless Security** sections for more information on setting up your wireless network.

Configuration

There are several different ways you can configure your router to connect to the Internet and connect to your clients:

- **Quick Setup Wizard** - This wizard will launch when you log into the router for the first time. Refer to page 14.
- **QRS Mobile App** - Use your iPhone, iPad, or iPod Touch to configure your router. Refer to page 21.
- **SharePort Mobile**- This will allow you to access files from a USB thumb drive that is plugged into your router. Refer to page 22.
- **Web Based Configuration Utility**- To access the configuration utility, open a web-browser such as Internet Explorer and enter the IP address of the router (<http://192.168.0.1>). Refer to page 26.

Quick Setup Wizard

If this is your first time installing the router, open your web browser. You will automatically be directed to the **Wizard Setup Screen**.

If you have already configured your settings and you would like to access the configuration utility, please refer to page 26.

If this is your first time logging into the router, this wizard will start automatically.

This wizard is designed to guide you through a step-by-step process to configure your new D-Link router and connect to the Internet.

Click **Next** to continue.

Please wait while your router detects your internet connection type. If the router detects your Internet connection, you may need to enter your ISP information such as username and password.

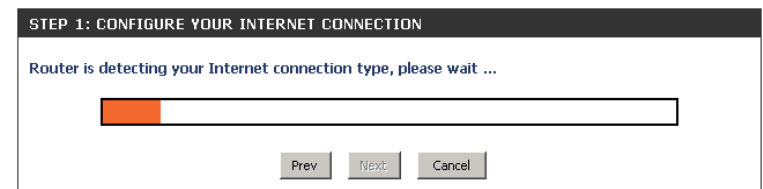
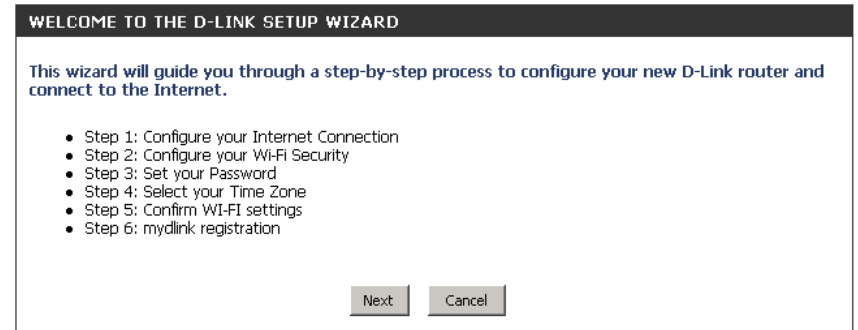
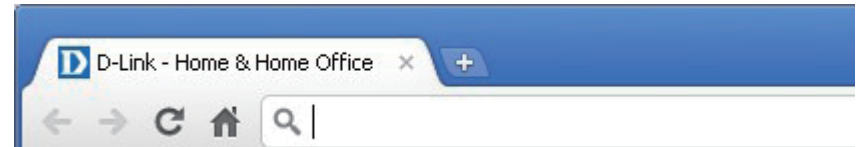

If the router does not detect a valid Ethernet connection from the Internet port, this screen will appear. Connect your broadband modem to the Internet port and then click **Try Again**.

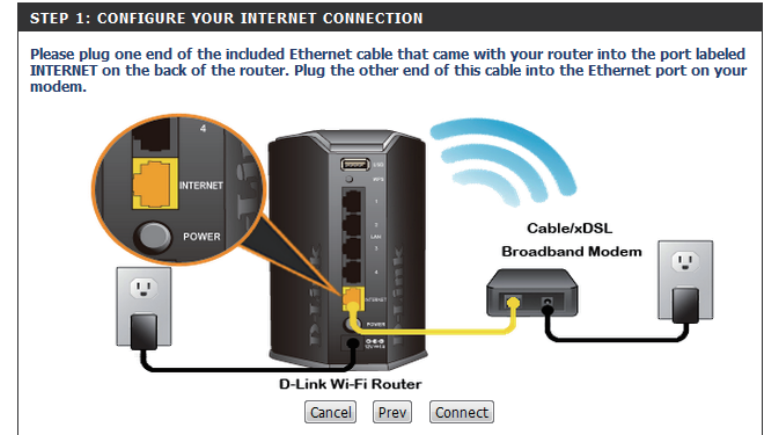

If the router detects an Ethernet connection but does not detect the type of Internet connection you have, this screen will appear. Click **Guide me through the Internet Connection Settings** to display a list of connection types to choose from.

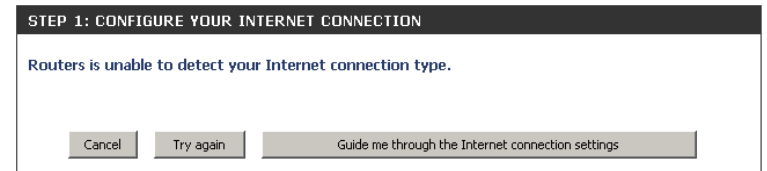

Select your Internet connection type and click **Next** to continue.

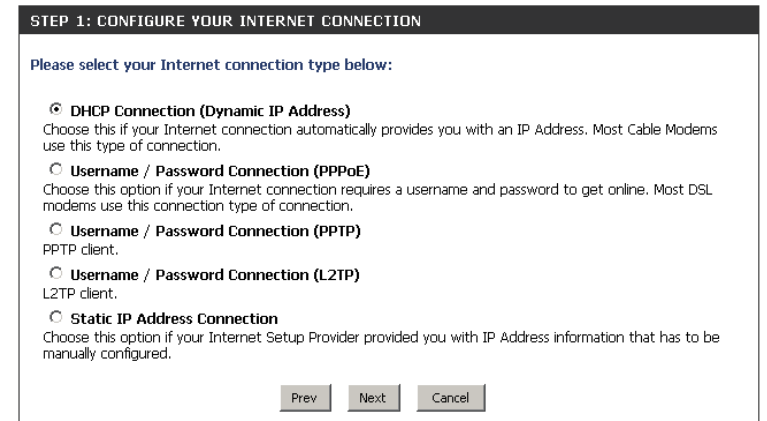

If the router detected or you selected **PPPoE**, enter your PPPoE username and password and click **Next** to continue.

Note: Make sure to remove your PPPoE software from your computer. The software is no longer needed and will not work through a router.

If the router detected or you selected **PPTP**, enter your PPTP username, password, and other information supplied by your ISP. Click **Next** to continue.

If the router detected or you selected **L2TP**, enter your L2TP username, password, and other information supplied by your ISP. Click **Next** to continue.

SET USERNAME AND PASSWORD CONNECTION (PPPoE)

To set up this connection you will need to have a Username and Password from your Internet Service Provider. If you do not have this information, please contact your ISP.

User Name :

Password :

Prev Next Cancel

SET USERNAME AND PASSWORD CONNECTION (PPTP)

To set up this connection you will need to have a Username and Password from your Internet Service Provider. You also need PPTP IP address. If you do not have this information, please contact your ISP.

Address Mode : Dynamic IP Static IP

PPTP IP Address :

PPTP Subnet Mask :

PPTP Gateway IP Address :

PPTP Server IP Address (may be same as gateway) :

User Name :

Password :

Verify Password :

DNS SETTINGS

Primary DNS Address :

Secondary DNS Address :

Prev Next Cancel

SET USERNAME AND PASSWORD CONNECTION (L2TP)

To set up this connection you will need to have a Username and Password from your Internet Service Provider. You also need L2TP IP address. If you do not have this information, please contact your ISP.

Address Mode : Dynamic IP Static IP

L2TP IP Address :

L2TP Subnet Mask :

L2TP Gateway IP Address :

L2TP Server IP Address (may be same as gateway) :

User Name :

Password :

Verify Password :

DNS SETTINGS

Primary DNS Address :

Secondary DNS Address :

Prev Next Cancel

If the router detected or you selected **Static**, enter the IP and DNS settings supplied by your ISP. Click **Next** to continue.

SET STATIC IP ADDRESS CONNECTION

To set up this connection you will need to have a complete list of IP information provided by your Internet Service Provider. If you have a Static IP connection and do not have this information, please contact your ISP.

IP Address :

Subnet Mask :

Gateway Address :

DNS SETTINGS

Primary DNS Address :

Secondary DNS Address :

For both the 2.4GHz and 5GHz segments, create a Wi-Fi network name (SSID) using up to 32 characters.

Create a Wi-Fi password (between 8-63 characters). Your wireless clients will need to have this passphrase or key entered to be able to connect to your wireless network.

Click **Next** to continue.

STEP 2: CONFIGURE YOUR WI-FI SECURITY

Give your Wi-Fi network a name and a password. (2.4GHz Band)

Wi-Fi Network Name (SSID) : (Using up to 32 characters)

Wi-Fi Password : (Between 8 and 63 characters)

Give your Wi-Fi network a name and a password. (5GHz Band)

Wi-Fi Network Name (SSID) : (Using up to 32 characters)

Wi-Fi Password : (Between 8 and 63 characters)

In order to secure your router, please enter a new password. Check the Enable Graphical Authentication box to enable CAPTCHA authentication for added security. Click **Next** to continue.

STEP 3: SET YOUR PASSWORD

By default, your new D-Link Router does not have a password configured for administrator access to the Web-based configuration pages. To secure your new networking device, please set and verify a password below, and enabling CAPTCHA Graphical Authentication provides added security protection to prevent unauthorized online users and hacker software from accessing your network settings.

Password:

Verify Password :

Enable Graphical Authentication :

Select your time zone from the drop-down menu and click **Next** to continue.

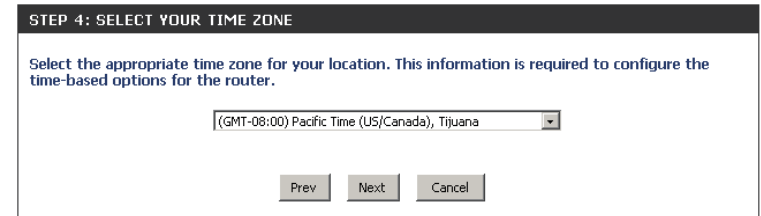

The Setup Complete window will display your Wi-Fi settings. Click **Save and Connect** to continue.

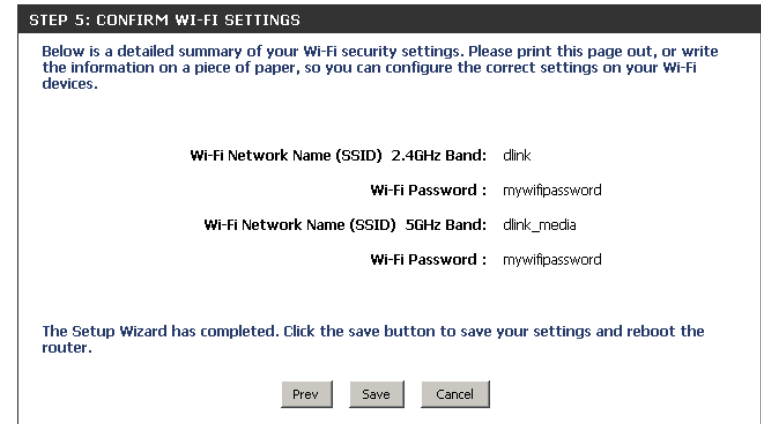

If you want to create a bookmark to the router, click **OK**. Click **Cancel** if you do not want to create a bookmark.

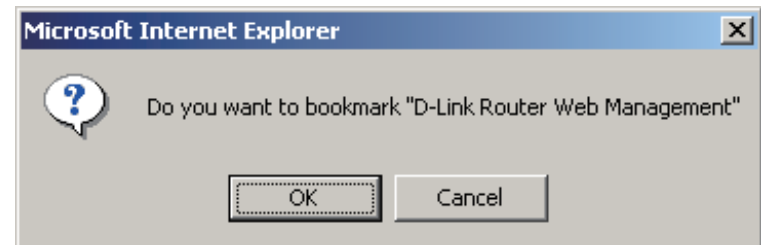

If you clicked **Yes**, a window may appear (depending on what web browser you are using) to create a bookmark.

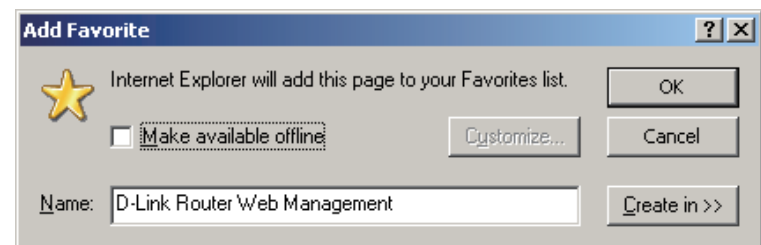

To use the mydlink service (mydlink.com or the mydlink Lite app), you must have an account. Select if you do have a mydlink account or if you need to create one. Click **Next** to continue.

If you do not want to register at this time, click **Cancel**.

If you clicked **Yes**, enter your mydlink account name (email address) and password. Click **Login** to register your router.

If you clicked **No**, fill out the requested information and click **Next** to create your mydlink account.

Once your account information is entered, click **Login**.

MYDLINK REGISTRATION

To use the features of mydlink.com and the mydlink Lite app, you will need an account with mydlink.com. If you already have an account, select Yes, I have a mydlink account and click Next to register the router with mydlink.com. If you do not have an account, select No, I want to register and login with a new mydlink account and click Next to create an account. If you do not wish to sign up for the mydlink service, please click Cancel.

Do you have mydlink account?

Yes, I have a mydlink account.

No, I want to register and login with a new mydlink account.

Next Cancel

STEP 6: MYDLINK REGISTRATION

E-mail Address (Account Name): mydlinkaccount

Password: *****

Login Prev Cancel

STEP 6: MYDLINK REGISTRATION

Please fill the options to complete the registration.

E-mail Address (Account Name) :

Password :

Confirm Password :

Last name :

First Name :

I Accept the mydlink terms and conditions.

Next Prev Cancel

STEP 6: MYDLINK REGISTRATION

To complete your mydlink registration, please check your Inbox for an email with confirmation instructions. After confirming your email address, click the Login button.

Login Cancel

The mydlink App will allow you to receive notices, browse network users, and configure your router from an iPhone/iPad/iPod Touch (iOS 3.0 or higher), Android device (1.6 or higher).

To download the "mydlink lite" app, visit the Apple Store, Android Market or <http://mydlink.com/Lite>.

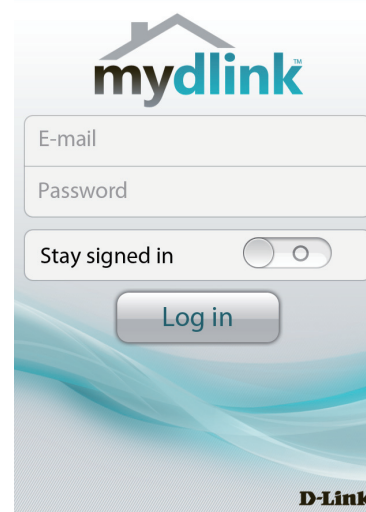

PC and Mac users can use the mydlink portal at <http://mydlink.com>.

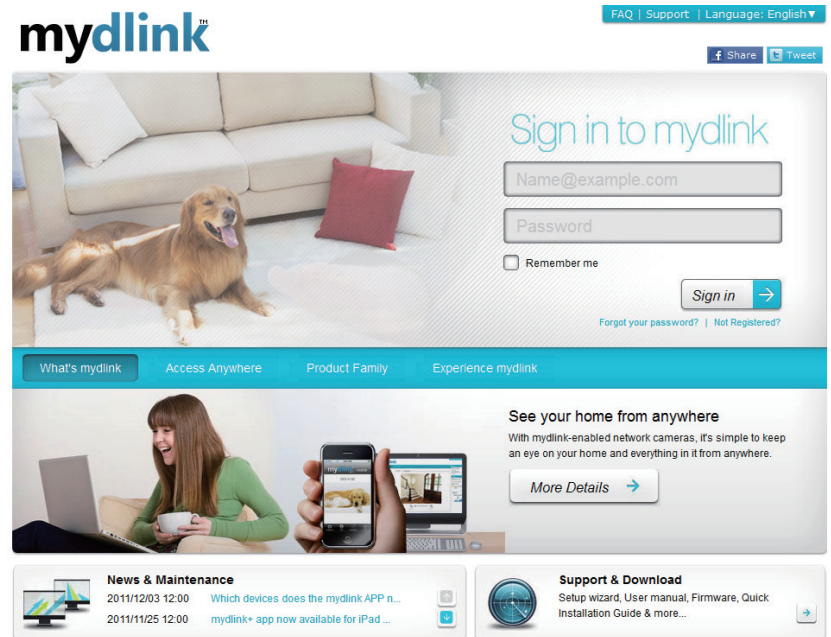

QRS Mobile App

D-Link offers an app for your iPad, iPod Touch, or iPhone (iOS 4.3 or higher) to install and configure your router.

Step 1

From your iPad, Touch, or iPhone, go to the iTunes Store and search for 'D-Link'. Select **QRS Mobile** and then download it.

You may also scan this code to download.

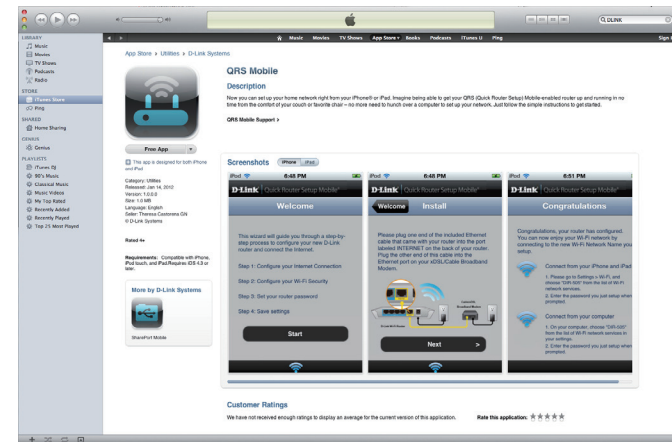

Step 2

Once your app is installed, you may now configure your router. Connect to the router wirelessly by going to your wireless utility on your device. Scan for the Wi-Fi name (SSID) as listed on the supplied info card. Select and then enter your Wi-Fi password.

D-Link DIR-826L Mobile Companion Wi-Fi Configuration Note

Web browser link: http://dlinkrouter or http://192.168.0.1	Web browser link: http://dlinkrouter or http://192.168.0.1
Default configuration Username: "Admin" Password: "" (leave the field blank)	Your configuration Username: Admin Password: <input type="text"/>
Wi-Fi Name (SSID): dlink-a8fa	Wi-Fi Name (SSID): <input type="text"/>
Wi-Fi Password: akbdj19368	Wi-Fi Password: <input type="text"/>

Step 3

Once you connect to the router, launch the QRS mobile app and it will guide you through the installation of your router.

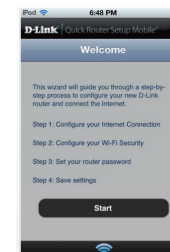

SharePort Mobile App

The SharePort Mobile app will allow you to access files from a USB thumb drive that is plugged into your router. You must enable file sharing from the **Setup > Storage** page (refer to page 53) for this app to work properly.

1. Insert your USB flash drive into DIR-826L.

2. Scan the bar code to download the **SharePort Mobile APP** from the app store to your iPhone or iPad.



3. From your iOS mobile device, click **Settings**.



4. Click **Wi-Fi**, select the Wi-Fi Network Name (SSID) that you created in the setup and then enter your Wi-Fi password.

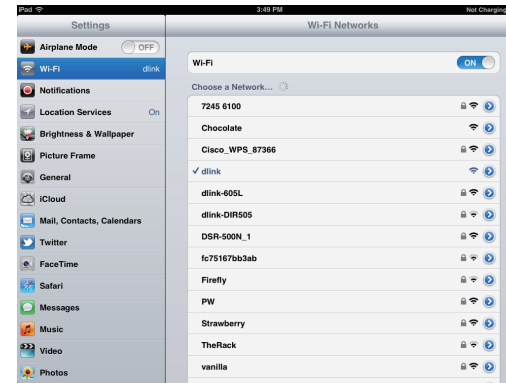

5. Once connected, click on the **SharePort Mobile** icon.



6. The following screen will appear.

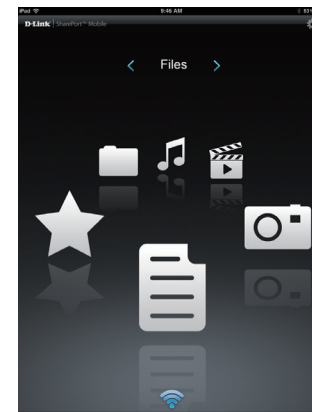

7. Click on **Settings** icon located on the right top corner of the screen. Click **Edit** to enter your User Name and Password. Once you finish, click **Done** to continue.

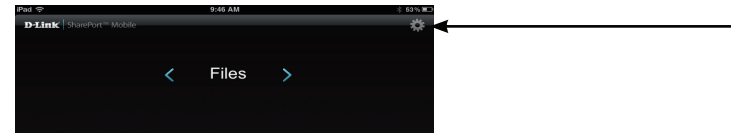

8. For the Movie section, click the movie icon to play your movie from your USB flash drive.

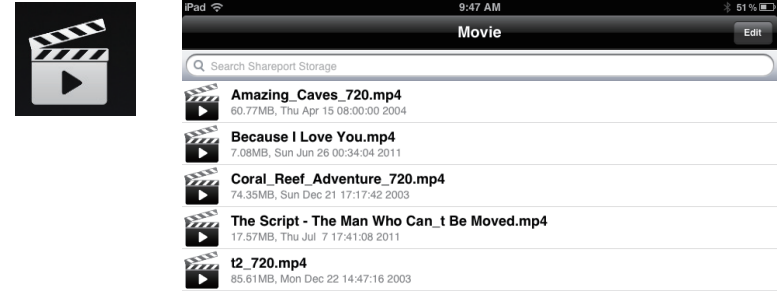

9. For the Music section, click the music icon to play your music from your USB flash drive.

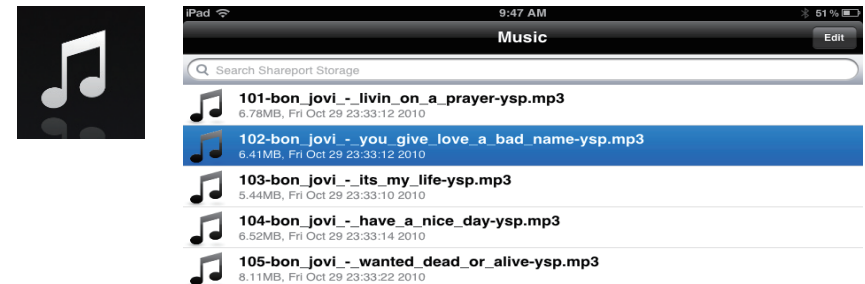

10. For the Photo section, click the Photo icon to view your photos from your USB flash drive.



11. For the Files section, click on the Files icon to view your files from your USB flash drive.

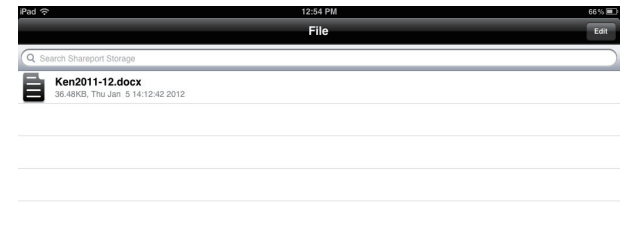

12. For the Folder section, click the folder icon to view your folders from your USB flash drive.

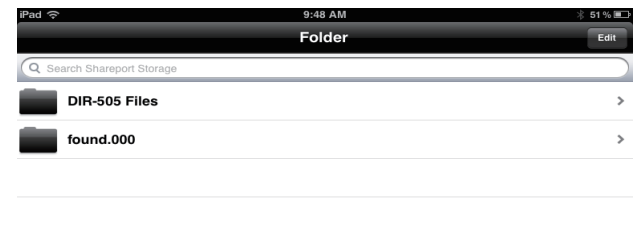
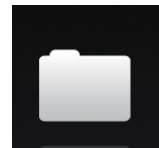

Web-based Configuration Utility

To access the configuration utility, open a web-browser such as Internet Explorer and enter the IP address of the router (**http://192.168.0.1**).

Windows and Mac users may also connect by typing **http://dlinkrouter** in the address bar.

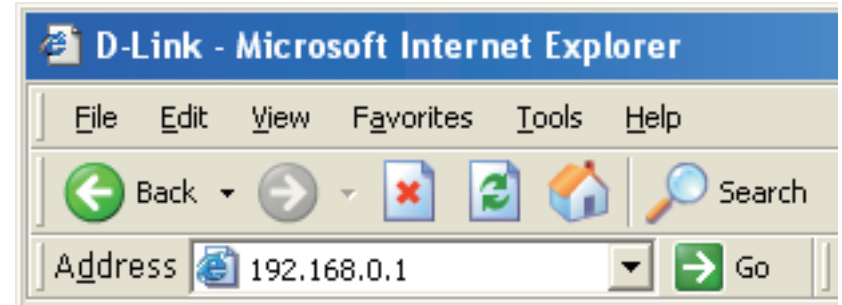

Select **Admin** from the drop-down menu and then enter your password. Leave the password blank by default.

A screenshot of the router's web-based configuration utility login page. The page has an orange header with the word "LOGIN" in white. Below the header, the text "Log in to the router" is displayed. There are two input fields: "User Name" with a dropdown menu currently showing "Admin", and "Password" with an empty text box. A "Login" button is positioned to the right of the password field.

Internet Connection Setup

Click **Manual Internet Connection Setup** to configure your connection manually and continue to the next page.

If you want to configure your router to connect to the Internet using the wizard, click **Internet Connection Setup Wizard**. You will be directed to the Quick Setup Wizard. Please refer to page 14.

The screenshot displays the D-Link DIR-826L web interface. The top navigation bar includes the D-Link logo and tabs for SETUP, ADVANCED, TOOLS, STATUS, and SUPPORT. The left sidebar lists menu items: INTERNET, WIRELESS SETTINGS, NETWORK SETTINGS, STORAGE, IPV6, and MYDLINK SETTINGS. The main content area is titled "INTERNET CONNECTION" and provides instructions on how to set up the Internet connection. It offers two options: the "INTERNET CONNECTION SETUP WIZARD" and "MANUAL INTERNET CONNECTION OPTIONS". The wizard option includes a button labeled "Internet Connection Setup Wizard" and a note advising users to follow the Quick Installation Guide. The manual option includes a button labeled "Manual Internet Connection Setup". A "Helpful Hints..." section on the right provides additional guidance for new and advanced users, with a "More..." link.

D-Link

DIR-826L //

SETUP ADVANCED TOOLS STATUS SUPPORT

INTERNET
WIRELESS SETTINGS
NETWORK SETTINGS
STORAGE
IPV6
MYDLINK SETTINGS

INTERNET CONNECTION

There are two ways to set up your Internet connection: you can use the Web-based Internet Connection Setup Wizard, or you can manually configure the connection.

INTERNET CONNECTION SETUP WIZARD

If you would like to utilize our easy to use Web-based Wizards to assist you in connecting your new D-Link Systems Router to the Internet, click on the button below.

Internet Connection Setup Wizard

Note : Before launching these wizards, please make sure you have followed all steps outlined in the Quick Installation Guide included in the package.

MANUAL INTERNET CONNECTION OPTIONS

If you would like to configure the Internet settings of your new D-Link Systems Router manually, then click on the button below.

Manual Internet Connection Setup

Helpful Hints...

If you are new to networking and have never configured a router before, click on **Internet Connection Setup Wizard** and the router will guide you through a few simple steps to get your network up and running.

If you consider yourself an advanced user and have configured a router before, click **Manual Internet Connection Setup** to input all the settings manually.

[More...](#)

WIRELESS

Manual Internet Setup

Static (assigned by ISP)

Select Static IP Address if all the Internet port's IP information is provided to you by your ISP. You will need to enter in the IP address, subnet mask, gateway address, and DNS address(es) provided to you by your ISP. Each IP address entered in the fields must be in the appropriate IP form, which are four octets separated by a dot (x.x.x.x). The Router will not accept the IP address if it is not in this format.

My Internet Connection: Select **Static IP** to manually enter the IP settings supplied by your ISP.

Enable Advanced DNS Service: Advanced Domain Name System (DNS) services enhances your Internet performance by getting you the information and web pages you are looking for faster and more reliably. In addition, it improves your overall Internet experience by correcting many common typo mistakes automatically, taking you where you intended to go and saving you valuable time.

***Disclaimer:** D-Link makes no warranty as to the availability, reliability, functionality and operation of the Advanced DNS service or its features.*

Enable True Gigabit Routing Connectivity: Check to enable true Gigabit routing. This will increase the through-put of the WAN-LAN connectivity of the router.

IP Address: Enter the IP address assigned by your ISP.

Subnet Mask: Enter the Subnet Mask assigned by your ISP.

Default Gateway: Enter the Gateway assigned by your ISP.

DNS Servers: The DNS server information will be supplied by your ISP (Internet Service Provider.)

MTU: Maximum Transmission Unit - you may need to change the MTU for optimal performance with your specific ISP. 1500 is the default MTU.

INTERNET CONNECTION TYPE

Choose the mode to be used by the router to connect to the Internet.

My Internet Connection is :

ADVANCED DNS SERVICE

Advanced DNS is a free security option that provides Anti-Phishing to protect your Internet connection from fraud and navigation improvements such as auto-correction of common URL typos.

Enable Advanced DNS Service :

TRUE GIGABIT ROUTING CONNECTIVITY SETTING

Enable True Gigabit Routing Connectivity :

STATIC IP ADDRESS INTERNET CONNECTION TYPE

Enter the static address information provided by your Internet Service Provider (ISP).

IP Address :

Subnet Mask :

Default Gateway :

Primary DNS Server :

Secondary DNS Server :

MTU : (bytes) MTU default = 1500

MAC Address :

Copy Your PC's MAC Address

MAC Address: The default MAC Address is set to the Internet port's physical interface MAC address on the Broadband Router. It is not recommended that you change the default MAC address unless required by your ISP. You can use the **Copy Your PC's MAC Address** button to replace the Internet port's MAC address with the MAC address of your Ethernet card.

Dynamic (Cable)

My Internet Connection: Select **Dynamic IP (DHCP)** to obtain IP Address information automatically from your ISP. Select this option if your ISP does not give you any IP numbers to use. This option is commonly used for cable modem services.

Enable Advanced DNS Service: Advanced Domain Name System (DNS) services enhances your Internet performance by getting you the information and web pages you are looking for faster and more reliably. In addition, it improves your overall Internet experience by correcting many common typo mistakes automatically, taking you where you intended to go and saving you valuable time.

Disclaimer: D-Link makes no warranty as to the availability, reliability, functionality and operation of the Advanced DNS service or its features.

Enable True Gigabit Routing Connectivity: Check to enable true Gigabit routing. This will increase the through-put of the WAN-LAN connectivity of the router.

Host Name: The Host Name is optional but may be required by some ISPs. Leave blank if you are not sure.

Use Unicasting: Check the box if you are having problems obtaining an IP address from your ISP.

Primary/Secondary DNS Server: Enter the Primary and secondary DNS server IP addresses assigned by your ISP. These addresses are usually obtained automatically from your ISP. Leave at 0.0.0.0 if you did not specifically receive these from your ISP.

MTU: Maximum Transmission Unit - you may need to change the MTU for optimal performance with your specific ISP. 1500 is the default MTU.

MAC Address: The default MAC Address is set to the Internet port's physical interface MAC address on the Broadband Router. It is not recommended that you change the default MAC address unless required by your ISP. You can use the **Copy Your PC's MAC Address** button to replace the Internet port's MAC address with the MAC address of your Ethernet card.

INTERNET CONNECTION TYPE

Choose the mode to be used by the router to connect to the Internet.

My Internet Connection is :

ADVANCED DNS SERVICE

Advanced DNS is a free security option that provides Anti-Phishing to protect your Internet connection from fraud and navigation improvements such as auto-correction of common URL typos.

Enable Advanced DNS Service :

TRUE GIGABIT ROUTING CONNECTIVITY SETTING

Enable True Gigabit Routing Connectivity :

DYNAMIC IP (DHCP) INTERNET CONNECTION TYPE

Use this Internet connection type if your Internet Service Provider (ISP) didn't provide you with IP Address information and/or a username and password.

Host Name :

Use Unicasting : (compatibility for some DHCP Servers)

Primary DNS Server :

Secondary DNS Server :

MTU : (bytes)MTU default = 1500

MAC Address :

Internet Setup

PPPoE (DSL)

Choose PPPoE (Point to Point Protocol over Ethernet) if your ISP uses a PPPoE connection. Your ISP will provide you with a username and password. This option is typically used for DSL services. Make sure to remove your PPPoE software from your computer. The software is no longer needed and will not work through a router.

My Internet Connection: Select **PPPoE (Username/Password)** from the drop-down menu.

Enable Advanced DNS Service: Advanced Domain Name System (DNS) services enhances your Internet performance by getting you the information and web pages you are looking for faster and more reliably. In addition, it improves your overall Internet experience by correcting many common typo mistakes automatically, taking you where you intended to go and saving you valuable time.

Disclaimer: D-Link makes no warranty as to the availability, reliability, functionality and operation of the Advanced DNS service or its features.

Enable True Gigabit Routing Connectivity: Check to enable true Gigabit routing. This will increase the through-put of the WAN-LAN connectivity of the router.

Address Mode: Select **Static IP** if your ISP assigned you the IP address, subnet mask, gateway, and DNS server addresses. In most cases, select **Dynamic**.

IP Address: Enter the IP address (Static PPPoE only).

User Name: Enter your PPPoE user name.

Password: Enter your PPPoE password and then retype the password in the next box.

Service Name: Enter the ISP Service Name (optional).

Reconnect Mode: Select either **Always-on**, **On-Demand**, or **Manual**.

INTERNET CONNECTION TYPE
Choose the mode to be used by the router to connect to the Internet.
My Internet Connection is : <input type="text" value="PPPoE (Username / Password)"/>
ADVANCED DNS SERVICE
Advanced DNS is a free security option that provides Anti-Phishing to protect your Internet connection from fraud and navigation improvements such as auto-correction of common URL typos.
Enable Advanced DNS Service : <input type="checkbox"/>
TRUE GIGABIT ROUTING CONNECTIVITY SETTING
Enable True Gigabit Routing Connectivity : <input type="checkbox"/>
PPPOE INTERNET CONNECTION TYPE
Enter the information provided by your Internet Service Provider (ISP).
Address Mode : <input checked="" type="radio"/> Dynamic IP (DHCP) <input type="radio"/> Static IP
IP Address : <input type="text" value="0.0.0.0"/>
Username : <input type="text"/>
Password : <input type="password" value="*****"/>
Verify Password : <input type="password" value="*****"/>
Service Name : <input type="text"/> (optional)
Reconnect Mode : <input type="radio"/> Always on <input checked="" type="radio"/> On demand <input type="radio"/> Manual
Maximum Idle Time : <input type="text" value="5"/> (minutes, 0=infinite)
Primary DNS Address : <input type="text" value="0.0.0.0"/> (Optional)
Secondary DNS Address : <input type="text" value="0.0.0.0"/> (Optional)
MTU : <input type="text" value="1492"/> (bytes) MTU default = 1492
MAC Address : <input type="text" value="00:18:E7:95:68:9F"/>
<input type="button" value="Clone Your PC's MAC Address"/>

Maximum Idle Time: Enter a maximum idle time during which the Internet connection is maintained during inactivity. To disable this feature, enable Auto-reconnect.

DNS Addresses: Enter the Primary and Secondary DNS Server Addresses (Static PPPoE only).

MTU: Maximum Transmission Unit - you may need to change the MTU for optimal performance with your specific ISP. 1492 is the default MTU.

MAC Address: The default MAC Address is set to the Internet port's physical interface MAC address on the Broadband Router. It is not recommended that you change the default MAC address unless required by your ISP. You can use the **Copy Your PC's MAC Address** button to replace the Internet port's MAC address with the MAC address of your Ethernet card.

Internet Setup

PPTP

Choose PPTP (Point-to-Point-Tunneling Protocol) if your ISP uses a PPTP connection. Your ISP will provide you with a username and password. This option is typically used for DSL services.

My Internet Connection: Select **PPTP (Username/Password)** from the drop-down menu.

Enable Advanced DNS Service: Advanced Domain Name System (DNS) services enhances your Internet performance by getting you the information and web pages you are looking for faster and more reliably. In addition, it improves your overall Internet experience by correcting many common typo mistakes automatically, taking you where you intended to go and saving you valuable time.

***Disclaimer:** D-Link makes no warranty as to the availability, reliability, functionality and operation of the Advanced DNS service or its features.*

Enable True Gigabit Routing Connectivity: Check to enable true Gigabit routing. This will increase the throughput of the WAN-LAN connectivity of the router.

Address Mode: Select **Static** if your ISP assigned you the IP address, subnet mask, gateway, and DNS server addresses. In most cases, select **Dynamic**.

PPTP IP Address: Enter the IP address (Static PPTP only).

PPTP Subnet Mask: Enter the Primary and Secondary DNS Server Addresses (Static PPTP only).

PPTP Gateway: Enter the Gateway IP Address provided by your ISP.

PPTP Server IP: Enter the Server IP provided by your ISP (optional).

INTERNET CONNECTION TYPE

Choose the mode to be used by the router to connect to the Internet.

My Internet Connection is : PPTP (Username / Password) ▾

ADVANCED DNS SERVICE

Advanced DNS is a free security option that provides Anti-Phishing to protect your Internet connection from fraud and navigation improvements such as auto-correction of common URL typos.

Enable Advanced DNS Service :

PPTP

Enter the information provided by your Internet Service Provider (ISP).

Address Mode : Dynamic IP (DHCP) Static IP

PPTP IP Address :

PPTP Subnet Mask :

PPTP Gateway IP Address :

PPTP Server IP Address :

Username :

Password :

Verify Password :

Reconnect Mode : Always on On demand Manual

Maximum Idle Time : (minutes, 0=infinite)

Primary DNS Address :

Secondary DNS Address :

MTU : (bytes)MTU default =1400

MAC Address :

Clone Your PC's MAC Address

Username: Enter your PPTP username.

Password: Enter your PPTP password and then retype the password in the next box.

Reconnect Mode: Select either **Always-on**, **On-Demand**, or **Manual**.

Maximum Idle Time: Enter a maximum idle time during which the Internet connection is maintained during inactivity. To disable this feature, enable Auto-reconnect.

DNS Servers: The DNS server information will be supplied by your ISP (Internet Service Provider.)

MTU: Maximum Transmission Unit - you may need to change the MTU for optimal performance with your specific ISP. 1400 is the default MTU.

MAC Address: The default MAC Address is set to the Internet port's physical interface MAC address on the Broadband Router. It is not recommended that you change the default MAC address unless required by your ISP. You can use the **Clone Your PC's MAC Address** button to replace the Internet port's MAC address with the MAC address of your Ethernet card.

Internet Setup

L2TP

Choose L2TP (Layer 2 Tunneling Protocol) if your ISP uses a L2TP connection. Your ISP will provide you with a username and password. This option is typically used for DSL services.

My Internet Connection: Select **L2TP (Username/Password)** from the drop-down menu.

Enable Advanced DNS Service: Advanced Domain Name System (DNS) services enhances your Internet performance by getting you the information and web pages you are looking for faster and more reliably. In addition, it improves your overall Internet experience by correcting many common typo mistakes automatically, taking you where you intended to go and saving you valuable time.

Disclaimer: D-Link makes no warranty as to the availability, reliability, functionality and operation of the Advanced DNS service or its features.

Enable True Gigabit Routing Connectivity: Check to enable true Gigabit routing. This will increase the through-put of the WAN-LAN connectivity of the router.

Address Mode: Select **Static** if your ISP assigned you the IP address, subnet mask, gateway, and DNS server addresses. In most cases, select **Dynamic**.

L2TP IP Address: Enter the L2TP IP address supplied by your ISP (Static only).

L2TP Subnet Mask: Enter the Subnet Mask supplied by your ISP (Static only).

L2TP Gateway: Enter the Gateway IP Address provided by your ISP.

L2TP Server IP: Enter the Server IP provided by your ISP (optional).

INTERNET CONNECTION TYPE

Choose the mode to be used by the router to connect to the Internet.

My Internet Connection is : L2TP (Username / Password) ▾

ADVANCED DNS SERVICE

Advanced DNS is a free security option that provides Anti-Phishing to protect your Internet connection from fraud and navigation improvements such as auto-correction of common URL typos.

Enable Advanced DNS Service :

L2TP

Enter the information provided by your Internet Service Provider (ISP).

Address Mode : Dynamic IP (DHCP) Static IP

L2TP :

L2TP Subnet Mask :

L2TP Gateway IP Address :

L2TP Server IP Address :

Username :

Password :

Verify Password :

Reconnect Mode : Always on On demand Manual

Maximum Idle Time : (minutes, 0=infinite)

Primary DNS Address :

Secondary DNS Address :

MTU : (bytes) MTU default = 1400

MAC Address :

Username: Enter your L2TP username.

Password: Enter your L2TP password and then retype the password in the next box.

Reconnect Mode: Select either **Always-on**, **On-Demand**, or **Manual**.

Maximum Idle Time: Enter a maximum idle time during which the Internet connection is maintained during inactivity. To disable this feature, enable Auto-reconnect.

DNS Servers: Enter the Primary and Secondary DNS Server Addresses (Static L2TP only).

MTU: Maximum Transmission Unit - you may need to change the MTU for optimal performance with your specific ISP. 1400 is the default MTU.

Clone MAC Address: The default MAC Address is set to the Internet port's physical interface MAC address on the Broadband Router. It is not recommended that you change the default MAC address unless required by your ISP. You can use the **Clone Your PC's MAC Address** button to replace the Internet port's MAC address with the MAC address of your Ethernet card.

Internet Setup

DS-Lite

Another Internet Connection type is DS-Lite.

DS-Lite is an IPv6 connection type. After selecting DS-Lite, the following parameters will be available for configuration:

DS-Lite Configuration: Select the DS-Lite DHCPv6 option to let the router allocate the AFTR IPv6 address automatically. Select the Manual Configuration to enter the AFTR IPv6 address in manually.

AFTR IPv6 Address: After selecting the Manual Configuration option above, enter the AFTR IPv6 address used here.

B4 IPv4 Address: Enter the B4 IPv4 address value used here.

WAN IPv6 Address: Once connected, the WAN IPv6 address will be displayed here.

IPv6 WAN Default Gateway: Once connected, the IPv6 WAN Default Gateway address will be displayed here.

INTERNET CONNECTION TYPE

Choose the mode to be used by the router to connect to the Internet.

My Internet Connection is :

AFTR ADDRESS INTERNET CONNECTION TYPE

Enter the AFTR address information provided by your Internet Service Provider(ISP).

DS-Lite Configuration DS-Lite DHCPv6 Option Manual Configuration

AFTR IPv6 Address :

B4 IPv4 Address : 192.0.0.1 (Optional)

WAN IPv6 Address :

IPv6 WAN Default Gateway :

Wireless Settings

If you want to configure the wireless settings on your router using the wizard, click **Wireless Security Setup Wizard** and refer to page 42.

Click **Add Wireless Device with WPS** if you want to add a wireless device using Wi-Fi Protected Setup (WPS) and refer to page 44.

If you want to manually configure the wireless settings on your router click **Manual Wireless Network Setup** and refer to the next page.

D-Link

DIR-826L //

SETUP ADVANCED TOOLS STATUS SUPPORT

INTERNET

WIRELESS SETTINGS

WIRELESS SETTINGS

NETWORK SETTINGS

STORAGE

IPv6

MYDLINK SETTINGS

WIRELESS SETTINGS

The following Web-based wizards are designed to assist you in your wireless network setup and wireless device connection.

Before launching these wizards, please make sure you have followed all steps outlined in the Quick Installation Guide included in the package.

WIRELESS NETWORK SETUP WIZARD

This wizard is designed to assist you in your wireless network setup. It will guide you through step-by-step instructions on how to set up your wireless network and how to make it secure.

Wireless Network Setup Wizard

Note : Some changes made using this Setup Wizard may require you to change some settings on your wireless client adapters so they can still connect to the D-Link Router.

ADD WIRELESS DEVICE WITH WPS (WI-FI PROTECTED SETUP) WIZARD

This wizard is designed to assist you in connecting your wireless device to your router. It will guide you through step-by-step instructions on how to get your wireless device connected. Click the button below to begin.

Add Wireless Device Wizard

MANUAL WIRELESS NETWORK SETUP

If your wireless network is already set up with Wi-Fi Protected Setup, manual configuration of the wireless network will destroy the existing wireless network. If you would like to configure the wireless settings of your new D-Link Systems Router manually, then click on the Manual Wireless Network Setup button below.

Manual Wireless Network Setup

WIRELESS

Helpful Hints ...

If you are new to wireless networking and have never configured a wireless router before, click on **Wireless Network Setup Wizard** and the router will guide you through a few simple steps to get your wireless network up and running.

If you consider yourself an advanced user and have configured a wireless router before, click **Manual Wireless Network Setup** to input all the settings manually.

More...

Manual Wireless Settings

802.11n/g (2.4GHz)

Enable Wireless: Check the box to enable the wireless function. If you do not want to use wireless, uncheck the box to disable all the wireless functions.

Schedule: Select the time frame that you would like your wireless network enabled. The schedule may be set to **Always**. Any schedule you create will be available in the drop-down menu. Click **New Schedule** to create a schedule.

Wireless Network Name: Service Set Identifier (SSID) is the name of your wireless network. Create a name for your wireless network using up to 32 characters. The SSID is case-sensitive.

WIRELESS NETWORK SETTINGS

Wireless Band : 2.4GHz Band

Enable Wireless : Always

Wireless Network Name : dlink (Also called the SSID)

802.11 Mode : Mixed 802.11n, 802.11g and 802.11b

Enable Auto Channel Scan :

Wireless Channel : 2.412 GHz - CH 1

Channel Width : Auto 20/40 MHz

Visibility Status : Visible Invisible

802.11 Mode: Select one of the following:

802.11b Only - Select only if all of your wireless clients are 802.11b.

802.11g Only - Select only if all of your wireless clients are 802.11g.

802.11n Only - Select only if all of your wireless clients are 802.11n.

Mixed 802.11g and 802.11b - Select if you are using both 802.11g and 802.11b wireless clients.

Mixed 802.11n and 802.11g - Select if you are using both 802.11n and 802.11g wireless clients.

Mixed 802.11n, 11g, and 11b - Select if you are using a mix of 802.11n, 802.11g, and 802.11b wireless clients.

Enable Auto Channel Scan: The **Auto Channel Scan** setting can be selected to allow the DIR-826L to choose the channel with the least amount of interference.

Wireless Channel: Indicates the channel setting for the DIR-826L. By default the channel is set to 6. The Channel can be changed to fit the channel setting for an existing wireless network or to customize the wireless network. If you enable **Auto Channel Scan**, this option will be greyed out.

Channel Width: Select the Channel Width:

Auto 20/40 - This is the default setting. Select if you are using both 802.11n and non-802.11n wireless devices.

20MHz - Select if you are not using any 802.11n wireless clients.

Visibility Status: Select **Invisible** if you do not want the SSID of your wireless network to be broadcasted by the DIR-826L. If Invisible is selected, the SSID of the DIR-826L will not be seen by Site Survey utilities so your wireless clients will have to know the SSID of your DIR-826L in order to connect to it.

Wireless Security: Refer to page 41 for more information regarding wireless security.

802.11n/a (5GHz)

Enable Wireless: Check the box to enable the wireless function. If you do not want to use wireless, uncheck the box to disable all the wireless functions.

Schedule: Select the time frame that you would like your wireless network enabled. The schedule may be set to **Always**. Any schedule you create will be available in the drop-down menu. Click **New Schedule** to create a schedule.

Wireless Network Name: Service Set Identifier (SSID) is the name of your wireless network. Create a name for your wireless network using up to 32 characters. The SSID is case-sensitive.

802.11 Mode: Select one of the following:
802.11a Only - Select if all of your wireless clients are 802.11a.
802.11n Only - Select only if all of your wireless clients are 802.11n.
Mixed 802.11n and 802.11a - Select if you are using both 802.11n and 802.11a wireless clients.

Enable Auto Channel Scan: The **Auto Channel Scan** setting can be selected to allow the DIR-826L to choose the channel with the least amount of interference.

Wireless Channel: Indicates the channel setting for the DIR-826L. By default the channel is set to 6. The Channel can be changed to fit the channel setting for an existing wireless network or to customize the wireless network. If you enable **Auto Channel Scan**, this option will be greyed out.

Channel Width: Select the Channel Width:
Auto 20/40 - This is the default setting. Select if you are using both 802.11n and non-802.11n wireless devices.
20MHz - Select if you are not using any 802.11n wireless clients.

Visibility Status: Select **Invisible** if you do not want the SSID of your wireless network to be broadcasted by the DIR-826L. If Invisible is selected, the SSID of the DIR-826L will not be seen by Site Survey utilities so your wireless clients will have to know the SSID of your DIR-826L in order to connect to it.

Wireless Security: Refer to the next page for more information regarding wireless security.

WIRELESS NETWORK SETTINGS

Wireless Band : 5GHz Band

Enable Wireless : Always

Wireless Network Name : dlink_media (Also called the SSID)

802.11 Mode : Mixed 802.11n and 802.11a

Enable Auto Channel Scan :

Wireless Channel : 5.180 GHz - CH 36

Channel Width : Auto 20/40 MHz

Visibility Status : Visible Invisible

Wireless Security

This section will show you the different levels of security you can use to protect your data from intruders. The DIR-826L offers the following types of security:

- WPA2 (Wi-Fi Protected Access 2)
- WPA (Wi-Fi Protected Access)
- WPA2-PSK (Pre-Shared Key)
- WPA-PSK (Pre-Shared Key)

What is WPA?

WPA (Wi-Fi Protected Access), is a Wi-Fi standard that was designed to improve the security features of WEP (Wired Equivalent Privacy).

The 2 major improvements over WEP:

- Improved data encryption through the Temporal Key Integrity Protocol (TKIP). TKIP scrambles the keys using a hashing algorithm and, by adding an integrity-checking feature, ensures that the keys haven't been tampered with. WPA2 is based on 802.11i and uses Advanced Encryption Standard (AES) instead of TKIP.
- User authentication, which is generally missing in WEP, through the extensible authentication protocol (EAP). WEP regulates access to a wireless network based on a computer's hardware-specific MAC address, which is relatively simple to be sniffed out and stolen. EAP is built on a more secure public-key encryption system to ensure that only authorized network users can access the network.

WPA-PSK/WPA2-PSK uses a passphrase or key to authenticate your wireless connection. The key is an alpha-numeric password between 8 and 63 characters long. The password can include symbols (!?*&_) and spaces. This key must be the exact same key entered on your wireless router or access point.

WPA/WPA2 incorporates user authentication through the Extensible Authentication Protocol (EAP). EAP is built on a more secure public key encryption system to ensure that only authorized network users can access the network.

Wireless Security Setup Wizard

To run the security wizard, click on Setup at the top and then click **Wireless Network Setup Wizard**.

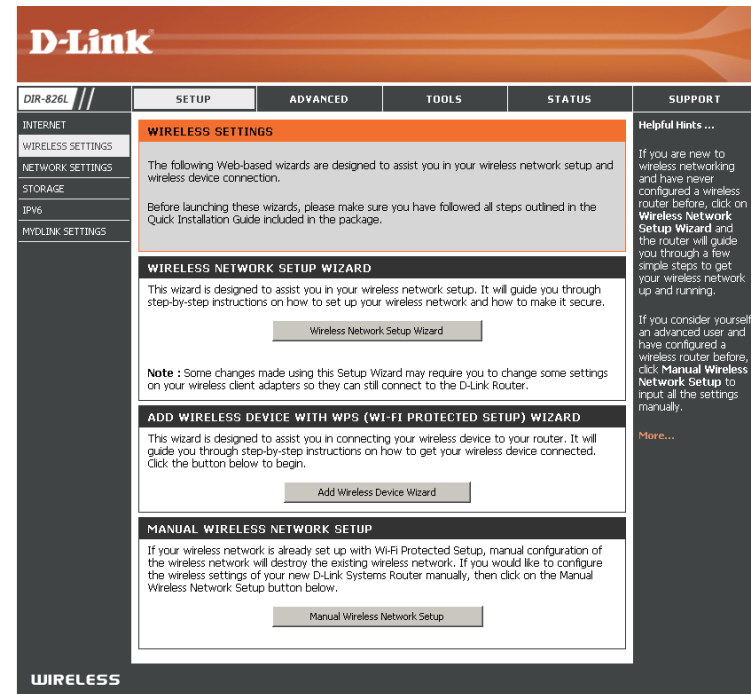

Type your desired wireless network name (SSID).

Automatically: Select this option to automatically generate the router's network key and click **Next**.

Manually: Select this option to manually enter your network key and click **Next**.

STEP 1: WELCOME TO THE D-LINK WIRELESS SECURITY SETUP WIZARD

Give your network a name, using up to 32 characters.

Network Name (SSID) 2.4GHz Band:

Manually set 5GHz band Network Name(SSID)

Network Name (SSID) 5GHz Band:

Automatically assign a network key for both 2.4GHz and 5GHz band (Recommended)
To prevent outsiders from accessing your network, the router will automatically assign a security (also called WEP or WPA key) to your network.

Manually assign a network key
Use this options if you prefer to create our own key.

Note: All D-Link wireless adapters currently support WPA.

If you selected **Automatically**, the summary window will display your settings. Write down the security key and enter this on your wireless clients. Click **Save** to save your settings.

SETUP COMPLETE!

Below is a detailed summary of your Wi-Fi security settings. Please print this page out, or write the information on a piece of paper, so you can configure the correct settings on your Wi-Fi devices.

2.4GHz Band Wireless Network Name (SSID) :		dlink
Security Mode :		Auto (WPA or WPA2) - Personal
Cipher Type :		TKIP and AES
Pre-Shared Key :		57f1b07af5

5GHz Band Wireless Network Name (SSID) :		dlink_media
Security Mode :		Auto (WPA or WPA2) - Personal
Cipher Type :		TKIP and AES
Pre-Shared Key :		a59b756af3

If you selected **Manually**, the following screen will appear. Create a passphrase for your security password. Click **Next** to continue.

STEP 2: SET YOUR WIRELESS SECURITY PASSWORD

You have selected your security level - you will need to set a wireless security password.

The WPA (Wi-Fi Protected Access) key must meet following guidelines

- Between 8 and 63 characters (A longer WPA key is more secure than a short one)
- Exactly 64 characters using 0-9 and A-F

Use the same Wireless Security Password on both 2.4GHz and 5GHz band

2.4GHz Band Wireless Security Password :	<input style="width: 80%;" type="password"/>
5GHz Band Wireless Security Password :	<input style="width: 80%;" type="password"/>

Note: You will need to enter the same password as keys in this step into your wireless clients in order to enable proper wireless communication.

Add Wireless Device with WPS Wizard

From the **Setup > Wireless Settings** screen, click **Add Wireless Device with WPS**.

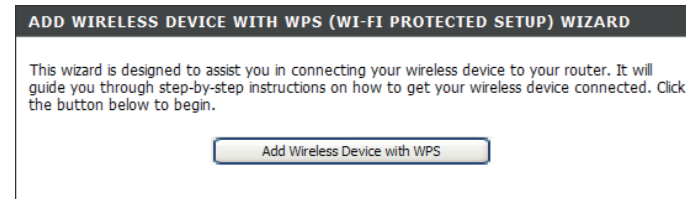

Select **Auto** to add a wireless client using WPS (Wi-Fi Protected Setup) and then click **Next**. Skip to the next page.

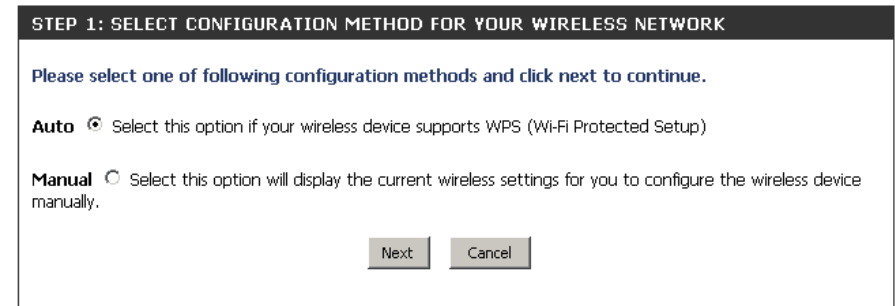

If you select **Manual**, a settings summary screen will appear. Write down the security key and enter this on your wireless clients. Click **OK** to finish.



PIN: Select this option to use PIN method. In order to use this method you must know the wireless client's 8 digit PIN and click **Connect**.

PBC: Select this option to use PBC (Push Button) method to add a wireless client. Click **Connect**.

Once you click **Connect**, you will have a 120 second time limit to apply the settings to your wireless client(s) and successfully establish a connection.

ADD WIRELESS DEVICE WITH WPS (WI-FI PROTECTED SETUP) WIZARD

There are two ways to add wireless device to your wireless network

- PIN (Personal Identification Number)
- PBC (Push Button Configuration)

PIN :

please enter the PIN from your wireless device and click the below "Connect" Button

PBC

please press the push button on your wireless device and click the below "Connect" Button within 120 seconds

ADD WIRELESS DEVICE WITH WPS

Please press down the Push Button (physical or virtual) on the wireless device you are adding to your wireless network within **117** seconds ...

WPA/WPA2-Personal (PSK)

It is recommended to enable encryption on your wireless router before your wireless network adapters. Please establish wireless connectivity before enabling encryption. Your wireless signal may degrade when enabling encryption due to the added overhead.

1. Log into the web-based configuration by opening a web browser and entering the IP address of the router (192.168.0.1). Click on **Setup** and then click **Wireless Settings** on the left side.
2. Next to *Security Mode*, select **WPA-Personal**.
3. Next to *WPA Mode*, select **Auto**, **WPA2 Only**, or **WPA Only**. Use **Auto** if you have wireless clients using both WPA and WPA2.
4. Next to *Cypher Type*, select **TKIP and AES**, **TKIP**, or **AES**.
5. Next to *Group Key Update Interval*, enter the amount of time before the group key used for broadcast and multicast data is changed (3600 is default).
6. Next to *Pre-Shared Key*, enter a key (passphrase). The key is entered as a pass-phrase in ASCII format at both ends of the wireless connection. The pass-phrase must be between 8-63 characters.
7. Click **Save Settings** to save your settings. If you are configuring the router with a wireless adapter, you will lose connectivity until you enable WPA-PSK on your adapter and enter the same passphrase as you did on the router.

WIRELESS SECURITY MODE

To protect your privacy you can configure wireless security features. This device supports three wireless security modes, including WEP, WPA-Personal, and WPA-Enterprise. WEP is the original wireless encryption standard. WPA provides a higher level of security. WPA-Personal does not require an authentication server. The WPA-Enterprise option requires an external RADIUS server.

Security Mode :

WPA

Use **WPA** or **WPA2** mode to achieve a balance of strong security and best compatibility. This mode uses WPA for legacy clients while maintaining higher security with stations that are WPA2 capable. Also the strongest cipher that the client supports will be used. For best security, use **WPA2 Only** mode. This mode uses AES(CCMP) cipher and legacy stations are not allowed access with WPA security. For maximum compatibility, use **WPA Only**. This mode uses TKIP cipher. Some gaming and legacy devices work only in this mode.

To achieve better wireless performance use **WPA2 Only** security mode (or in other words AES cipher).

WPA Mode :

Cipher Type :

Group Key Update Interval : (seconds)

PRE-SHARED KEY

Enter an 8- to 63-character alphanumeric pass-phrase. For good security it should be of ample length and should not be a commonly known phrase.

Pre-Shared Key :

Configure WPA/WPA2-Enterprise (RADIUS)

It is recommended to enable encryption on your wireless router before your wireless network adapters. Please establish wireless connectivity before enabling encryption. Your wireless signal may degrade when enabling encryption due to the added overhead.

1. Log into the web-based configuration by opening a web browser and entering the IP address of the router (192.168.0.1). Click on **Setup** and then click **Wireless Settings** on the left side.
2. Next to *Security Mode*, select **WPA-Enterprise**.
3. Next to *WPA Mode*, select **Auto, WPA2 Only, or WPA Only**. Use **Auto** if you have wireless clients using both WPA and WPA2.
4. Next to *Cypher Type*, select **TKIP and AES, TKIP, or AES**.
5. Next to *Group Key Update Interval*, enter the amount of time before the group key used for broadcast and multicast data is changed (3600 is default).
6. Next to *Authentication Timeout*, enter the amount of time before a client is required to re-authenticate (60 minutes is default).
7. Next to *RADIUS Server IP Address* enter the IP Address of your RADIUS server.

WIRELESS SECURITY MODE

To protect your privacy you can configure wireless security features. This device supports three wireless security modes including WEP, WPA-Personal, and WPA-Enterprise. WEP is the original wireless encryption standard. WPA provides a higher level of security. WPA-Personal does not require an authentication server. The WPA-Enterprise option requires an external RADIUS server.

Security Mode :

WPA

Use **WPA or WPA2** mode to achieve a balance of strong security and best compatibility. This mode uses WPA for legacy clients while maintaining higher security with stations that are WPA2 capable. Also the strongest cipher that the client supports will be used. For best security, use **WPA2 Only** mode. This mode uses AES(CCMP) cipher and legacy stations are not allowed access with WPA security. For maximum compatibility, use **WPA Only**. This mode uses TKIP cipher. Some gaming and legacy devices work only in this mode.

To achieve better wireless performance use **WPA2 Only** security mode (or in other words AES cipher).

WPA Mode :

Cipher Type :

Group Key Update Interval : (seconds)

EAP (802.1X)

When WPA enterprise is enabled, the router uses EAP (802.1x) to authenticate clients via a remote RADIUS server. MAC Address Authentication

Authentication Timeout : (minutes)

RADIUS server IP Address :

RADIUS server Port :

RADIUS server Shared Secret :

Second MAC Address Authentication :

8. Next to *RADIUS Server Port*, enter the port you are using with your RADIUS server. 1812 is the default port.
9. Next to *RADIUS Server Shared Secret*, enter the security key.
10. If the *MAC Address Authentication* box is selected then the user will need to connect from the same computer whenever logging into the wireless network.
11. Click **Advanced** to enter settings for a secondary RADIUS Server.
12. Click **Apply Settings** to save your settings.

EAP (802.1X)

When WPA enterprise is enabled, the router uses EAP (802.1x) to authenticate clients via a remote RADIUS server. **MAC Address Authentication**

Authentication Timeout :	<input type="text" value="60"/>	(minutes)
RADIUS server IP Address :	<input type="text" value="0.0.0.0"/>	
RADIUS server Port :	<input type="text" value="1812"/>	
RADIUS server Shared Secret :	<input type="text" value="***"/>	
Second MAC Address Authentication :	<input checked="" type="checkbox"/>	

Optional backup RADIUS server :

Second RADIUS server IP Address :	<input type="text" value="0.0.0.0"/>	
Second RADIUS server Port :	<input type="text" value="1812"/>	
Second RADIUS server Shared Secret :	<input type="text" value="***"/>	
Second MAC Address Authentication :	<input checked="" type="checkbox"/>	

Network Settings

This section will allow you to change the local network settings of the router and to configure the DHCP settings.

Router Settings

Router IP Address: Enter the IP address of the router. The default IP address is 192.168.0.1.

If you change the IP address, once you click **Save Settings**, you will need to enter the new IP address in your browser to get back into the configuration utility.

Subnet Mask: Enter the Subnet Mask. The default subnet mask is 255.255.255.0.

Device Name: Enter a name for the router.

Local Domain: Enter the Domain name (Optional).

Enable DNS Relay: Uncheck the box to transfer the DNS server information from your ISP to your computers. If checked, your computers will use the router for a DNS server.

ROUTER SETTINGS
Use this section to configure the internal network settings of your router. The IP Address that is configured here is the IP Address that you use to access the Web-based management interface. If you change the IP Address here, you may need to adjust your PC's network settings to access the network again.
Router IP Address :
Subnet Mask :
Device Name :
Local Domain Name :
Enable DNS Relay :

DHCP Server Settings

DHCP stands for Dynamic Host Control Protocol. The DIR-826L has a built-in DHCP server. The DHCP Server will automatically assign an IP address to the computers on the LAN/private network. Be sure to set your computers to be DHCP clients by setting their TCP/IP settings to "Obtain an IP Address Automatically." When you turn your computers on, they will automatically load the proper TCP/IP settings provided by the DIR-826L. The DHCP Server will automatically allocate an unused IP address from the IP address pool to the requesting computer. You must specify the starting and ending address of the IP address pool.

Enable DHCP Server: Check this box to enable the DHCP server on your router.
Server: Uncheck to disable this function.

DHCP IP Address Range: Enter the starting and ending IP addresses for the DHCP server's IP assignment.

Note: If you statically (manually) assign IP addresses to your computers or devices, make sure the IP addresses are outside of this range or you may have an IP conflict.

DHCP Lease Time: The length of time for the IP address lease. Enter the Lease time in minutes.

Always Broadcast: Enable this feature to broadcast your networks DHCP server to LAN/WLAN clients.

NetBIOS Announcement: NetBIOS allows LAN hosts to discover all other computers within the network, enable this feature to allow the DHCP Server to offer NetBIOS configuration settings.

Learn NetBIOS from WAN: Enable this feature to allow WINS information to be learned from the WAN side, disable to allow manual configuration.

NetBIOS Scope: This feature allows the configuration of a NetBIOS 'domain' name under which network hosts operates. This setting has no effect if the 'Learn NetBIOS information from WAN' is activated.

DHCP SERVER SETTINGS

Use this section to configure the built-in DHCP Server to assign IP addresses to the computers on your network.

Enable DHCP Server :

DHCP IP Address Range : to

DHCP Lease Time : (minutes)

Always broadcast : (compatibility for some DHCP Clients)

NetBIOS announcement :

Learn NetBIOS from WAN :

NetBIOS Scope : (Optional)

NetBIOS node type : Broadcast only (use when no WINS servers configured)
 Point-to-Point (no broadcast)
 Mixed-mode (Broadcast then Point-to-Point)
 Hybrid (Point-to-Point then Broadcast)

Primary WINS IP Address :

Secondary WINS IP Address :

NetBIOS Node: Select the different type of NetBIOS node; **Broadcast only, Point-to-Point, Mixed-mode,** and **Hybrid.**

WINS IP Enter your WINS Server IP address(es).

Address:

DHCP Reservation

If you want a computer or device to always have the same IP address assigned, you can create a DHCP reservation. The router will assign the IP address only to that computer or device.

Note: This IP address must be within the DHCP IP Address Range.

Enable: Check this box to enable the reservation.

Computer Name: Enter the computer name or select from the drop-down menu and click <<.

IP Address: Enter the IP address you want to assign to the computer or device. This IP Address must be within the DHCP IP Address Range.

MAC Address: Enter the MAC address of the computer or device.

Copy Your PC's MAC Address: If you want to assign an IP address to the computer you are currently on, click this button to populate the fields.

Save: Click **Save** to save your entry. You must click **Save Settings** at the top to activate your reservations.

DHCP Reservations List

DHCP Reservations List: Displays any reservation entries. Displays the host name (name of your computer or device), MAC Address, and IP address.

Enable: Check to enable the reservation.

Edit: Click the edit icon to make changes to the reservation entry.

Delete: Click to remove the reservation from the list.



ADD DHCP RESERVATION

Enable :



Computer Name : <<

IP Address :

MAC Address :

DHCP RESERVATIONS LIST				
Enable	Host Name	MAC Address	IP Address	
<input checked="" type="checkbox"/>	PM_test01	00:04:23:2c:51:a3	192.168.0.112	 

NUMBER OF DYNAMIC DHCP CLIENTS : 1				
Hardware Address	Assigned IP	Hostname	Expires	
00:04:23:2c:51:a3	192.168.0.112	PM_test01	Thu Sep 1 19:49:06 2011	Revoke Reserve

DHCP RESERVATIONS LIST				
Enable	Host Name	MAC Address	IP Address	
<input checked="" type="checkbox"/>	PM_test01	00:04:23:2c:51:a3	192.168.0.112	 

NUMBER OF DYNAMIC DHCP CLIENTS : 1				
Hardware Address	Assigned IP	Hostname	Expires	
00:04:23:2c:51:a3	192.168.0.112	PM_test01	Thu Sep 1 19:49:06 2011	Revoke Reserve

Storage

This page will allow you to access files from a USB external hard drive or thumb drive that is plugged into the router from your local network or from the Internet using either a web browser or an app for your smartphone or tablet. You can create users to be allowed to access these files.

Enable Web File Access: Check to enable sharing files on your USB storage device that is plugged in your router.

Enable HTTP Storage Remote Access: Check to enable HTTP access to your router's storage. You will have to type HTTP in the URL.

Remote Access Port: Enter a port (8181 is default). You will have to enter this port in the URL when connecting to the shared files. For example: (**http://192.168.0.1:8181**).

Enable HTTPS Storage Remote Access: Check to enable HTTPS (secure) access to your router's storage. You will have to type HTTPS in the URL.

Remote HTTPS Port: Enter a port (4433 is default). You will have to enter this port in the URL when connecting to the shared files. For example: (**https://192.168.0.1:4433**).

User Name: To create a new user, enter a user name.

Password: Enter a password for this account.

Verify Password: Re-enter the password. Click **Add/Edit** to create the user.

User List: Displays the accounts. The Admin and Guest accounts are built-in to the router.

Number of Devices: Displays the USB device plugged into the router.

HTTP STORAGE

Enable Web File Access :

Enable HTTP Storage Remote Access :

Remote Access Port :

Enable HTTPS Storage Remote Access :

Remote HTTPS Port :

10 -- USER CREATION

User Name : << User Name ▾

Password :

Verify Password : Add/Edit

USER LIST

: Modify : Delete

No.	User Name	Access Path	Permission
1	Admin	/	Read/Write
2	Guest	None	Read Only

NUMBER OF DEVICE:

Device	Total Space	Free Space

HTTP STORAGE LINK

You can use this link to connect to the drive remotely after logging in with a user account.

Access Files from the Internet

If you would like to access your files that are on your USB thumb drive or external hard drive that is connected to your router, follow the steps below:

Step 1 - Enable Web File Access

Check the Enable Web File Access checkbox to enable. Then select if you want to use HTTP or HTTPS (secure) and enter the port(s) you want to use. The default for HTTP is 8181 and HTTPS is 4433.

Step 2 - Create a User Account

Under *User Creation*, enter a username and password, and then click **Add/Edit**.

Step 3 - Configure your Access Path

Under *User List*, click the **Modify** icon for the user you just created. Here you can browse to the folder on your USB storage device you want to assign the Access Path to.

Step 4 - Save Settings

If you want to add more users, repeat steps 3 and 4. Once you are finished, click the **Save Settings** button at the top to save your settings.

Note that under the HTTP Storage Link (at the bottom) will display the URL(s) you can use to connect. Also if you selected HTTPS, you must type in **HTTPS://** instead of **HTTP://** to get a secure connection.

For example, if you selected HTTPS and changed the port to 3200, and your WAN IP address is 1.2.3.4, then you would enter **HTTPS://1.2.3.4:3200** to connect.

HTTP STORAGE

Enable Web File Access :

Enable HTTP Storage Remote Access :

Remote Access Port :

Enable HTTPS Storage Remote Access :

Remote HTTPS Port :

10 -- USER CREATION

User Name : << User Name ▾

Password :

Verify Password :

USER LIST

: Modify
 : Delete

No.	User Name	Access Path	Permission
1	admin	/	Read/Write
2	guest	None	Read Only
3	d-link	(1) /Storage(B0)/	Read/Write

NUMBER OF DEVICES : 1

Device	Total Space	Free Space
Storage(B0)	15.04 GB	14.65 GB

IPv6

On this page, the user can configure the IPv6 Connection type. There are two ways to set up the IPv6 Internet connection. You can use the Web-based IPv6 Internet Connection Setup Wizard, or you can manually configure the connection.

For the beginner user that has not configured a router before, click on the **IPv6 Internet Connection Setup Wizard** button and the router will guide you through a few simple steps to get your network up and running.

For the advanced user that has configured a router before, click on the **Manual IPv6 Internet Connection Setup** button to input all the settings manually.

To configure the IPv6 local settings, click on the **IPv6 Local Connectivity Setup** button.

The screenshot shows the D-Link web interface for the DIR-826L router. The main navigation menu includes SETUP, ADVANCED, TOOLS, STATUS, and SUPPORT. The left sidebar lists various settings categories: INTERNET, WIRELESS SETTINGS, NETWORK SETTINGS, STORAGE, IPV6, and MYDLINK SETTINGS. The main content area is titled "IPV6 INTERNET CONNECTION" and provides instructions on how to set up the connection. It offers two options: "IPV6 INTERNET CONNECTION SETUP WIZARD" and "MANUAL IPV6 LOCAL CONNECTIVITY SETUP". A "Helpful Hints" section on the right provides additional guidance for users.

This section is titled "IPV6 LOCAL CONNECTIVITY SETTINGS". It instructs the user to configure Unique Local IPv6 Unicast Addresses (ULA) settings for their router. The text states: "Use this section to configure Unique Local IPv6 Unicast Addresses(ULA) settings for your router. ULA is intended for local communications and not expected to be routable on the global Internet." At the bottom, there are two buttons: "Save Settings" and "Don't Save Settings".

This section is titled "IPV6 ULA SETTINGS". It contains the following configuration options:

- Enable ULA :
- Use Default ULA Prefix :
- ULA Prefix : /64

This section is titled "CURRENT IPV6 ULA SETTINGS". It displays the current configuration for the ULA settings:

- Current ULA Prefix :
- LAN IPv6 ULA :

IPv6 Internet Connection Setup Wizard

On this page, the user can configure the IPv6 Connection type using the IPv6 Internet Connection Setup Wizard.

Click the **IPv6 Internet Connection Setup Wizard** button and the router will guide you through a few simple steps to get your network up and running.



Click **Next** to continue to the next page. Click **Cancel** to discard the changes made and return to the main page.

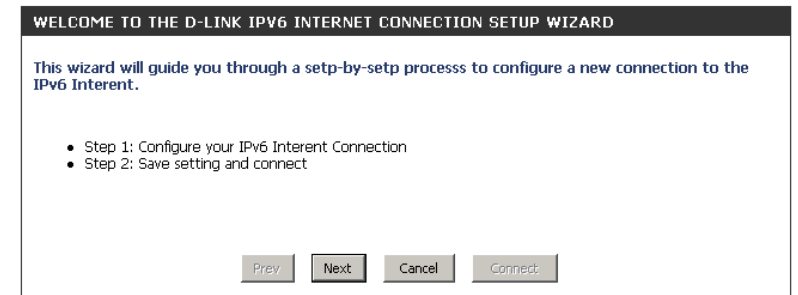

The router will try to detect whether its possible to obtain the IPv6 Internet connection type automatically. If this succeeds then the user will be guided through the input of the appropriate parameters for the connection type found.

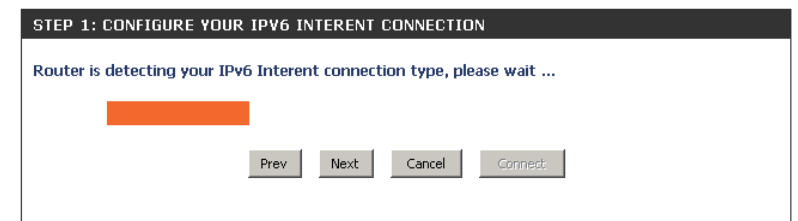

However, if the automatic detection fails, the user will be prompt to either **Try again** or to click on the **Guide me through the IPv6 settings** button to initiate the manual continual of the wizard.

There are several connection types to choose from. If you are unsure of your connection method, please contact your IPv6 Internet Service Provider.

Note: If using the PPPoE option, you will need to ensure that any PPPoE client software on your computers has been removed or disabled. The 3 options available on this page are **IPv6 over PPPoE**, **Static IPv6 address and Route**, and **Tunneling Connection**.

Choose the required IPv6 Internet Connection type and click on the **Next** button to continue. Click on the **Prev** button to return to the previous page. Click on the **Cancel** button to discard all the changes made and return to the main page.

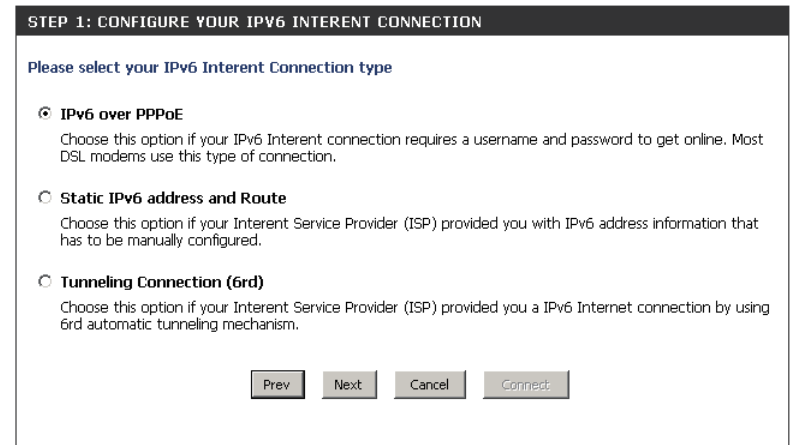
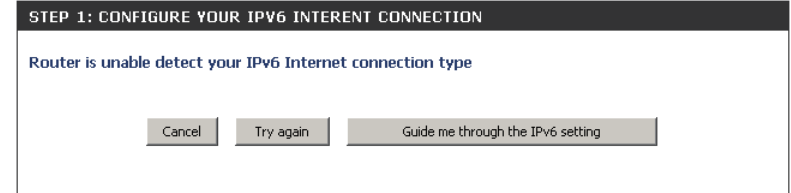

Click on the **Next** button to continue. Click on the **Prev** button to return to the previous page.

Click on the **Cancel** button to discard all the changes made and return to the main page.

IPv6 over PPPoE

After selecting the IPv6 over PPPoE option, the user will be able to configure the IPv6 Internet connection that requires a username and password to get online. Most DSL modems use this type of connection.

The following parameters will be available for configuration:

PPPoE Session: Select the PPPoE Session value used here. This option will state that this connection shares its information with the already configured IPv6 PPPoE connection, or the user can create a new PPPoE connection here.

User Name: Enter the PPPoE username used here. If you do not know your user name, please contact your ISP.

Password: Enter the PPPoE password used here. If you do not know your password, please contact your ISP.

Verify Password: Re-enter the PPPoE password used here.

Service Name: Enter the service name for this connection here. This option is optional.

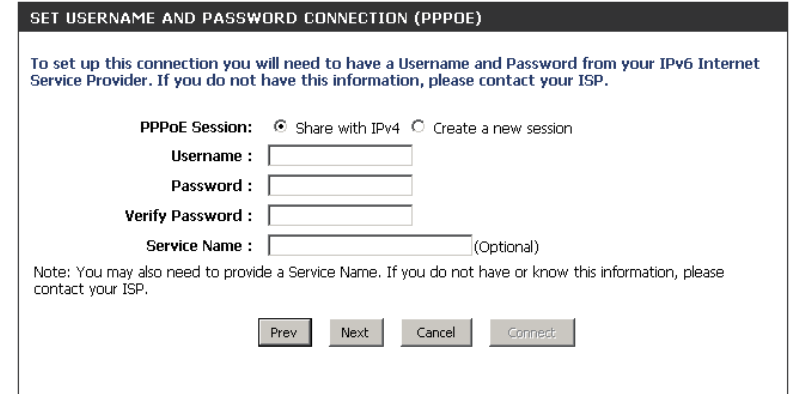

SET USERNAME AND PASSWORD CONNECTION (PPPoE)

To set up this connection you will need to have a Username and Password from your IPv6 Internet Service Provider. If you do not have this information, please contact your ISP.

PPPoE Session: Share with IPv4 Create a new session

Username :

Password :

Verify Password :

Service Name : (Optional)

Note: You may also need to provide a Service Name. If you do not have or know this information, please contact your ISP.

Static IPv6 Address Connection

This mode is used when your ISP provides you with a set IPv6 addresses that does not change. The IPv6 information is manually entered in your IPv6 configuration settings. You must enter the IPv6 address, Subnet Prefix Length, Default Gateway, Primary DNS Server, and Secondary DNS Server. Your ISP provides you with all this information.

Use Link-Local Address: The Link-local address is used by nodes and routers when communicating with neighboring nodes on the same link. This mode enables IPv6-capable devices to communicate with each other on the LAN side.

IPv6 Address: Enter the WAN IPv6 address for the router here.

Subnet Prefix Length: Enter the WAN subnet prefix length value used here.

Default Gateway: Enter the WAN default gateway IPv6 address used here.

Primary IPv6 DNS Address: Enter the WAN primary DNS Server address used here.

Secondary IPv6 DNS Address: Enter the WAN secondary DNS Server address used here.

LAN IPv6 Address: These are the settings of the LAN (Local Area Network) IPv6 interface for the router. The router's LAN IPv6 Address configuration is based on the IPv6 Address and Subnet assigned by your ISP. (A subnet with prefix /64 is supported in LAN.)

SET STATIC IPv6 ADDRESS CONNECTION

To set up this connection you will need to have a complete list of IPv6 information provided by your IPv6 Internet Service Provider. If you have a Static IPv6 connection and do not have this information, please contact your ISP.

Use Link-Local Address :

IPv6 Address :

Subnet Prefix Length :

Default Gateway :

Primary DNS Address :

Secondary DNS Address :

LAN IPv6 Address : /64

Tunneling Connection (6rd)

After selecting the Tunneling Connection (6rd) option, the user can configure the IPv6 6rd connection settings.

The following parameters will be available for configuration:

6rd IPv6 Prefix: Enter the 6rd IPv6 address and prefix value used here.

IPv4 Address: Enter the IPv4 address used here.

Mask Length: Enter the IPv4 mask length used here.

Assigned IPv6 Prefix: Displays the IPv6 assigned prefix value here.

6rd Border Relay IPv4 Address: Enter the 6rd border relay IPv4 address used here.

IPv6 DNS Server: Enter the primary DNS Server address used here.

SET UP 6RD TUNNELING CONNECTION

To set up this 6rd tunneling connection you will need to have the following information from your IPv6 Internet Service Provider. If you do not have this information, please contact your ISP.

6rd IPv6 Prefix : /

IPv4 Address : 192.168.1.2 Mask Length :

Assign IPv6 Prefix : None

Tunnel Link-Local Address : FE80::COA8:0102/64

6rd Border Relay IPv4 Address :

IPv6 DNS Server :

The IPv6 Internet Connection Setup Wizard is complete.

Click on the **Connect** button to continue. Click on the **Prev** button to return to the previous page. Click on the **Cancel** button to discard all the changes made and return to the main page.

SETUP COMPLETE!

The IPv6 Internet Connection Setup Wizard has completed. Click the Connect button to save your settings and reboot the router.

IPv6 Manual Setup

There are several connection types to choose from: Auto Detection, Static IPv6, Autoconfiguration (SLAAC/DHCPv6), PPPoE, IPv6 in IPv4 Tunnel, 6to4, 6rd, and Link-local. If you are unsure of your connection method, please contact your IPv6 Internet Service Provider.

Note: If using the PPPoE option, you will need to ensure that any PPPoE client software on your computers has been removed or disabled.

Auto Detection

Select **Auto Detection** to have the router detect and automatically configure your IPv6 setting from your ISP.

IPv6 CONNECTION TYPE
Choose the mode to be used by the router to the IPv6 Internet.
My IPv6 Connection is : <input type="text" value="Auto Detection"/>
IPv6 DNS SETTINGS
Obtain a DNS server address automatically or enter a specific DNS server address.
<input checked="" type="radio"/> Obtain a DNS server address automatically <input type="radio"/> Use the following DNS address
Primary DNS Server : <input type="text"/>
Secondary DNS Server : <input type="text"/>
LAN IPv6 ADDRESS SETTINGS
Use this section to configure the internal network settings of your router. If you change the LAN IPv6 Address here, you may need to adjust your PC network settings to access the network again.
Enable DHCP-PD : <input checked="" type="checkbox"/>
LAN IPv6 Address : <input type="text"/> /64
LAN IPv6 Link-Local Address : FE80::218:E7FF:FE95:689E/64
ADDRESS AUTOCONFIGURATION SETTINGS
Use this section to setup IPv6 Autoconfiguration to assign IP addresses to the computers on your network. You can also enable DHCP-PD to delegate prefixes for router in your LAN.
Enable automatic IPv6 address assignment : <input checked="" type="checkbox"/>
Enable Automatic DHCP-PD in LAN : <input checked="" type="checkbox"/>
Autoconfiguration Type : <input type="text" value="SLAAC + Stateless DHCPv6"/>
Router Advertisement Lifetime: <input type="text" value="1440"/> (minutes)

Static IPv6

My IPv6 Connection: Select **Static IPv6** from the drop-down menu.

WAN IPv6 Address Settings: Enter the address settings supplied by your Internet provider (ISP).

LAN IPv6 Address: Enter the LAN (local) IPv6 address for the router.

LAN Link-Local Address: Displays the Router's LAN Link-Local Address.

Enable Autoconfiguration: Check to enable the Autoconfiguration feature.

Autoconfiguration Type: Select **Stateful (DHCPv6)**, **SLAAC + RDNSS** or **SLAAC + Stateless DHCPv6**.

IPv6 Address Range Start: Enter the start IPv6 Address for the DHCPv6 range for your local computers.

IPv6 Address Range End: Enter the end IPv6 Address for the DHCPv6 range for your local computers.

IPv6 Address Lifetime: Enter the IPv6 Address Lifetime (in minutes).

IPv6 CONNECTION TYPE	
Choose the mode to be used by the router to the IPv6 Internet.	
My IPv6 Connection is :	Static IPv6
WAN IPv6 ADDRESS SETTINGS	
Enter the IPv6 address information provided by your Internet Service Provider (ISP).	
Use Link-Local Address :	<input checked="" type="checkbox"/>
IPv6 Address :	FE80::218:E7FF:FE95:689F
Subnet Prefix Length :	64
Default Gateway :	
Primary DNS Server :	
Secondary DNS Server :	
LAN IPv6 ADDRESS SETTINGS	
Use this section to configure the internal network settings of your router. If you change the LAN IPv6 Address here, you may need to adjust your PC network settings to access the network again.	
LAN IPv6 Address :	/64
LAN IPv6 Link-Local Address :	FE80::218:E7FF:FE95:689E/64
ADDRESS AUTOCONFIGURATION SETTINGS	
Use this section to setup IPv6 Autoconfiguration to assign IP addresses to the computers on your network.	
Enable automatic IPv6 address assignment :	<input checked="" type="checkbox"/>
Autoconfiguration Type :	SLAAC + Stateless DHCPv6
Router Advertisement Lifetime:	1440 (minutes)

Autoconfiguration

My IPv6 Connection: Select **Autoconfiguration (Stateless/DHCPv6)** from the drop-down menu.

IPv6 DNS Settings: Select either **Obtain DNS server address automatically** or **Use the following DNS Address.**

Primary/Secondary DNS Address: Enter the primary and secondary DNS server addresses.

LAN IPv6 Address: Enter the LAN (local) IPv6 address for the router.

LAN Link-Local Address: Displays the Router's LAN Link-Local Address.

Enable Autoconfiguration: Check to enable the Autoconfiguration feature.

Autoconfiguration Type: Select **Stateful (DHCPv6)**, **SLAAC + RDNSS** or **SLAAC + Stateless DHCPv6.**

IPv6 Address Range Start: Enter the start IPv6 Address for the DHCPv6 range for your local computers.

IPv6 Address Range End: Enter the end IPv6 Address for the DHCPv6 range for your local computers.

IPv6 Address Lifetime: Enter the IPv6 Address Lifetime (in minutes).

IPv6 CONNECTION TYPE	
Choose the mode to be used by the router to the IPv6 Internet.	
My IPv6 Connection is :	Autoconfiguration (SLAAC/DHCPv6) ▾
IPv6 DNS SETTINGS	
Obtain a DNS server address automatically or enter a specific DNS server address.	
<input checked="" type="radio"/> Obtain a DNS server address automatically <input type="radio"/> Use the following DNS address	
Primary DNS Server :	<input type="text"/>
Secondary DNS Server :	<input type="text"/>
LAN IPv6 ADDRESS SETTINGS	
Use this section to configure the internal network settings of your router. If you change the LAN IPv6 Address here, you may need to adjust your PC network settings to access the network again.	
Enable DHCP-PD :	<input checked="" type="checkbox"/>
LAN IPv6 Address :	<input type="text"/> /64
LAN IPv6 Link-Local Address :	FE80::218:E7FF:FE95:689E/64
ADDRESS AUTOCONFIGURATION SETTINGS	
Use this section to setup IPv6 Autoconfiguration to assign IP addresses to the computers on your network. You can also enable DHCP-PD to delegate prefixes for router in your LAN.	
Enable automatic IPv6 address assignment :	<input checked="" type="checkbox"/>
Enable Automatic DHCP-PD in LAN :	<input checked="" type="checkbox"/>
Autoconfiguration Type :	SLAAC + Stateless DHCPv6 ▾
Router Advertisement Lifetime :	1440 (minutes)

PPPoE

My IPv6 Connection: Select **PPPoE** from the drop-down menu.

PPPoE: Enter the PPPoE account settings supplied by your Internet provider (ISP).

Address Mode: Select **Static** if your ISP assigned you the IP address, subnet mask, gateway, and DNS server addresses. In most cases, select **Dynamic**.

IP Address: Enter the IP address (Static PPPoE only).

User Name: Enter your PPPoE user name.

Password: Enter your PPPoE password and then retype the password in the next box.

Service Name: Enter the ISP Service Name (optional).

Reconnection Mode: Select either **Always-on**, **On-Demand**, or **Manual**.

Maximum Idle Time: Enter a maximum idle time during which the Internet connection is maintained during inactivity. To disable this feature, enable Auto-reconnect.

MTU: Maximum Transmission Unit - you may need to change the MTU for optimal performance with your specific ISP. 1492 is the default MTU.

IPv6 DNS Settings: Select either **Obtain DNS server address automatically** or **Use the following DNS Address**.

Primary/Secondary DNS Address: Enter the primary and secondary DNS server addresses.

LAN IPv6 Address: Enter the LAN (local) IPv6 address for the router.

LAN Link-Local Address: Displays the Router's LAN Link-Local Address.

Enable Autoconfiguration: Check to enable the Autoconfiguration feature.

IPv6 CONNECTION TYPE	
Choose the mode to be used by the router to the IPv6 Internet.	
My IPv6 Connection is :	PPPoE
PPPOE	
Enter the information provided by your Internet Service Provider (ISP).	
PPPoE Session:	<input checked="" type="radio"/> Share with IPv4 <input type="radio"/> Create a new session
Address Mode :	<input checked="" type="radio"/> Dynamic IP <input type="radio"/> Static IP
IP Address :	<input type="text"/>
Username :	<input type="text"/>
Password :	<input type="text"/>
Verify Password :	<input type="text"/>
Service Name :	<input type="text"/> (Optional)
Reconnect Mode :	<input checked="" type="radio"/> Always on <input type="radio"/> On demand <input type="radio"/> Manual
Maximum Idle Time :	5 (minutes, 0=infinite)
MTU :	1492 (bytes)MTU default = 1492
IPv6 DNS SETTINGS	
Obtain a DNS server address automatically or enter a specific DNS server address.	
	<input checked="" type="radio"/> Obtain a DNS server address automatically
	<input type="radio"/> Use the following DNS address
Primary DNS Server :	<input type="text"/>
Secondary DNS Server :	<input type="text"/>
LAN IPv6 ADDRESS SETTINGS	
Use this section to configure the internal network settings of your router. If you change the LAN IPv6 Address here, you may need to adjust your PC network settings to access the network again.	
Enable DHCP-PD :	<input checked="" type="checkbox"/>
LAN IPv6 Address :	<input type="text"/> /64
LAN IPv6 Link-Local Address :	FE80::218:E7FF:FE95:689E/64
ADDRESS AUTOCONFIGURATION SETTINGS	
Use this section to setup IPv6 Autoconfiguration to assign IP addresses to the computers on your network.You can also enable DHCP-PD to delegate prefixes for router in your LAN.	
Enable automatic IPv6 address assignment :	<input checked="" type="checkbox"/>
Enable Automatic DHCP-PD in LAN :	<input checked="" type="checkbox"/>
Autoconfiguration Type :	SLAAC + Stateless DHCPv6
Router Advertisement Lifetime:	1440 (minutes)

Autoconfiguration Type: Select **Stateful (DHCPv6)**, **SLAAC + RDNSS** or **SLAAC + Stateless DHCPv6**.

IPv6 Address Range Start: Enter the start IPv6 Address for the DHCPv6 range for your local computers.

IPv6 Address Range End: Enter the end IPv6 Address for the DHCPv6 range for your local computers.

IPv6 Address Lifetime: Enter the IPv6 Address Lifetime (in minutes).

IPv6 in IPv4 Tunneling

My IPv6 Connection: Select **IPv6 in IPv4 Tunnel** from the drop-down menu.

IPv6 in IPv4 Tunnel Settings: Enter the settings supplied by your Internet provider (ISP).

LAN IPv6 Address: Enter the LAN (local) IPv6 address for the router.

LAN Link-Local Address: Displays the Router's LAN Link-Local Address.

Enable Autoconfiguration: Check to enable the Autoconfiguration feature.

Autoconfiguration Type: Select **Stateful (DHCPv6)**, **SLAAC + RDNSS** or **SLAAC + Stateless DHCPv6**.

IPv6 Address Range Start: Enter the start IPv6 Address for the DHCPv6 range for your local computers.

IPv6 Address Range End: Enter the end IPv6 Address for the DHCPv6 range for your local computers.

Pv6 Address Lifetime: Enter the Router Advertisement Lifetime (in minutes).

IPv6 CONNECTION TYPE	
Choose the mode to be used by the router to the IPv6 Internet.	
My IPv6 Connection is :	IPv6 in IPv4 Tunnel
IPv6 in IPv4 TUNNEL SETTINGS	
Enter the IPv6 in IPv4 Tunnel information provided by your Tunnel Broker.	
Remote IPv4 Address :	
Remote IPv6 Address :	
Local IPv4 Address :	192.168.1.2
Local IPv6 Address :	
IPv6 DNS SETTINGS	
Obtain a DNS server address automatically or enter a specific DNS server address.	
<input checked="" type="radio"/> Obtain a DNS server address automatically <input type="radio"/> Use the following DNS address	
Primary DNS Server :	
Secondary DNS Server :	
LAN IPv6 ADDRESS SETTINGS	
Use this section to configure the internal network settings of your router. If you change the LAN IPv6 Address here, you may need to adjust your PC network settings to access the network again.	
Enable DHCP-PD :	<input checked="" type="checkbox"/>
LAN IPv6 Address :	/64
LAN IPv6 Link-Local Address :	FE80::218:E7FF:FE95:689E/64
ADDRESS AUTOCONFIGURATION SETTINGS	
Use this section to setup IPv6 Autoconfiguration to assign IP addresses to the computers on your network. You can also enable DHCP-PD to delegate prefixes for router in your LAN.	
Enable automatic IPv6 address assignment :	<input checked="" type="checkbox"/>
Enable Automatic DHCP-PD in LAN :	<input checked="" type="checkbox"/>
Autoconfiguration Type :	SLAAC + Stateless DHCPv6
Router Advertisement Lifetime:	1440 (minutes)

6 to 4 Tunneling

My IPv6 Connection: Select **6 to 4** from the drop-down menu.

6 to 4 Settings: Enter the IPv6 settings supplied by your Internet provider (ISP).

Primary/Secondary DNS Address: Enter the primary and secondary DNS server addresses.

LAN IPv6 Address: Enter the LAN (local) IPv6 address for the router.

LAN Link-Local Address: Displays the Router's LAN Link-Local Address.

Enable Autoconfiguration: Check to enable the Autoconfiguration feature.

Autoconfiguration Type: Select **Stateful (DHCPv6)**, **SLAAC + RDNSS** or **SLAAC + Stateless DHCPv6**.

IPv6 Address Range Start: Enter the start IPv6 Address for the DHCPv6 range for your local computers.

IPv6 Address Range End: Enter the end IPv6 Address for the DHCPv6 range for your local computers.

IPv6 Address Lifetime: Enter the IPv6 Address Lifetime (in minutes).

IPv6 CONNECTION TYPE	
Choose the mode to be used by the router to the IPv6 Internet.	
My IPv6 Connection is :	6to4
6to4 SETTINGS	
Enter the IPv6 address information provided by your Internet Service Provider (ISP).	
6to4 Address :	2002:COA8:0102::COA8:0102
6to4 Relay :	192.88.99.1
Primary DNS Server :	
Secondary DNS Server :	
LAN IPv6 ADDRESS SETTINGS	
Use this section to configure the internal network settings of your router. If you change the LAN IPv6 Address here, you may need to adjust your PC network settings to access the network again.	
LAN IPv6 Address :	2002:COA8:0102:0001::1/64
LAN IPv6 Link-Local Address :	FE80::218:E7FF:FE95:689E/64
ADDRESS AUTOCONFIGURATION SETTINGS	
Use this section to setup IPv6 Autoconfiguration to assign IP addresses to the computers on your network.	
Enable automatic IPv6 address assignment :	<input checked="" type="checkbox"/>
Autoconfiguration Type :	SLAAC + Stateless DHCPv6
Router Advertisement Lifetime :	60 (minutes)

6rd

My IPv6 Connection: Select **6rd** from the drop-down menu.

6RD Settings: Enter the address settings supplied by your Internet provider (ISP).

LAN IPv6 Address: Enter the LAN (local) IPv6 address for the router.

LAN Link-Local Address: Displays the Router's LAN Link-Local Address.

Enable Autoconfiguration: Check to enable the Autoconfiguration feature.

Autoconfiguration Type: Select **Stateful (DHCPv6)**, **SLAAC+RDNSS** or **SLAAC + Stateless DHCPv6**.

Router Advertisement Lifetime: Enter the Router Advertisement Lifetime (in minutes).

IPv6 CONNECTION TYPE
Choose the mode to be used by the router to the IPv6 Internet.
My IPv6 Connection is : <input type="text" value="6rd"/>
6RD SETTINGS
Enter the IPv6 address information provided by your Internet Service Provider (ISP).
6rd Configuration : <input checked="" type="radio"/> 6rd DHCPv4 Option <input type="radio"/> Manual Configuration
6rd IPv6 Prefix : <input type="text"/> / <input type="text" value="32"/>
IPv4 Address : 192.168.1.2 Mask Length : <input type="text" value="0"/>
Assign IPv6 Prefix : None
Tunnel Link-Local Address : FE80::C0A8:0102/64
6rd Border Relay IPv4 Address : <input type="text"/>
Primary DNS Server : <input type="text"/>
Secondary DNS Server : <input type="text"/>
LAN IPv6 ADDRESS SETTINGS
Use this section to configure the internal network settings of your router. If you change the LAN IPv6 Address here, you may need to adjust your PC network settings to access the network again.
LAN IPv6 Address : None
LAN IPv6 Link-Local Address : FE80::218:E7FF:FE95:689E/64
ADDRESS AUTOCONFIGURATION SETTINGS
Use this section to setup IPv6 Autoconfiguration to assign IP addresses to the computers on your network.
Enable automatic IPv6 address assignment : <input checked="" type="checkbox"/>
Autoconfiguration Type : <input type="text" value="SLAAC + Stateless DHCPv6"/>
Router Advertisement Lifetime : <input type="text" value="60"/> (minutes)

Link-Local Connectivity

My IPv6 Connection: Select **Link-Local Only** from the drop-down menu.

LAN IPv6 Address Settings: Displays the IPv6 address of the router.

IPv6 CONNECTION TYPE

Choose the mode to be used by the router to the IPv6 Internet.

My IPv6 Connection is :

LAN IPv6 ADDRESS SETTINGS

LAN IPv6 address for local IPv6 communications.

LAN IPv6 Link-Local Address : FE80::218:E7FF:FE95:689E/64

mydlink Settings

mydlink Service: Displays whether your device is registered with a mydlink account or not.

Register mydlink Settings: Click to go to the mydlink website to register or edit your settings.

The screenshot displays the D-Link DIR-826L web interface. The top navigation bar includes the D-Link logo and tabs for SETUP, ADVANCED, TOOLS, STATUS, and SUPPORT. A left sidebar lists configuration categories: INTERNET, WIRELESS SETTINGS, NETWORK SETTINGS, STORAGE, IPV6, and MYDLINK SETTINGS. The main content area is titled "MYDLINK SETTINGS" and contains the following text: "Setting and registering your product with mydlink will allow you to use its mydlink cloud services features, including online access and management of your device through mydlink portal website." Below this text are two buttons: "Save Settings" and "Don't Save Settings". A section titled "MYDLINK" shows "mydlink Service : Non-Registered". A section titled "REGISTER MYDLINK SERVICE" contains a "Register mydlink Service" button. A right sidebar offers "Helpful Hints..." and "More...". The "WIRELESS" label is visible at the bottom left of the interface.

Advanced Virtual Server

This will allow you to open a single port. If you would like to open a range of ports, refer to the next page.

Name: Enter a name for the rule or select an application from the drop-down menu. Select an application and click << to populate the fields.

IP Address: Enter the IP address of the computer on your local network that you want to allow the incoming service to. If your computer is receiving an IP address automatically from the router (DHCP), you computer will be listed in the "Computer Name" drop-down menu. Select your computer and click <<.

Private Port/ Public Port: Enter the port that you want to open next to Private Port and Public Port. The private and public ports are usually the same. The public port is the port seen from the Internet side, and the private port is the port being used by the application on the computer within your local network.

Protocol Type: Select **TCP**, **UDP**, or **Both** from the drop-down menu.

Schedule: The schedule of time when the Virtual Server Rule will be enabled. The schedule may be set to Always, which will allow the particular service to always be enabled. You can create your own times in the **Tools** > **Schedules** section.

Inbound Filter: Select **Allow All** (most common) or a created Inbound filter. You may create your own inbound filters in the **Advanced** > **Inbound Filter** page.

The screenshot shows the D-Link DIR-826L Advanced Virtual Server configuration page. The page is divided into several sections:

- Navigation:** A sidebar on the left contains menu items: VIRTUAL SERVER, PORT FORWARDING, APPLICATION RULES, QOS ENGINE, NETWORK FILTER, ACCESS CONTROL, WEBSITE FILTER, INBOUND FILTER, FIREWALL SETTINGS, ROUTING, ADVANCED WIRELESS, WI-FI PROTECTED SETUP, ADVANCED NETWORK, GUEST ZONE, IPV6 FIREWALL RULES, and IPV6 ROUTING.
- Virtual Server Configuration:** The main area is titled "VIRTUAL SERVER" and contains a description: "The Virtual Server option allows you to define a single public port on your router for redirection to an internal LAN IP Address and Private LAN port if required. This feature is useful for hosting online services such as FTP or Web Servers." Below this are "Save Settings" and "Don't Save Settings" buttons.
- Virtual Servers List:** A table titled "24--- VIRTUAL SERVERS LIST" displays a list of configured virtual servers. Each entry includes a checkbox, a Name field (with a drop-down menu for Application Name), an IP Address field (with a drop-down menu for Computer Name), Public and Private Port fields, a Protocol Type field, and an Inbound Filter field.
- Helpful Hints:** A sidebar on the right provides additional information:
 - Helpful Hints ...**: Check the Application Name drop down menu for a list of predefined server types. If you select one of the predefined server types, click the arrow button next to the drop down menu to fill out the corresponding field.
 - You can select a computer from the list of DHCP clients in the Computer Name drop down menu, or you can manually enter the IP address of the computer at which you would like to open the specified port.
 - Select a schedule for when the virtual server will be enabled. If you do not see the schedule you need in the list of schedules, go to the Tools → Schedules screen and create a new schedule.
 - Select a filter that restricts the Internet hosts that can access this virtual server to.

Port Forwarding

This will allow you to open a single port or a range of ports.

Name: Enter a name for the rule or select an application from the drop-down menu. Select an application and click << to populate the fields.

IP Address: Enter the IP address of the computer on your local network that you want to allow the incoming service to. If your computer is receiving an IP address automatically from the router (DHCP), your computer will be listed in the “Computer Name” drop-down menu. Select your computer and click <<.

TCP/UDP: Enter the TCP and/or UDP port or ports that you want to open. You can enter a single port or a range of ports. Separate ports with a common.

Example: 24,1009,3000-4000

Schedule: The schedule of time when the Virtual Server Rule will be enabled. The schedule may be set to **Always**, which will allow the particular service to always be enabled. You can create your own times in the **Tools > Schedules** section.

Inbound Filter: Select **Allow All** (most common) or a created Inbound filter. You may create your own inbound filters in the **Advanced > Inbound Filter** page.

D-Link

DIR-826L // SETUP ADVANCED TOOLS STATUS SUPPORT

PORT FORWARDING

This option is used to open multiple ports or a range of ports in your router and redirect data through those ports to a single PC on your network. This feature allows you to enter ports in various formats including, Port Ranges (100-150), Individual Ports (80, 68, 888), or Mixed (1020-5000, 689).

Save Settings Don't Save Settings

24--PORT FORWARDING RULES

	Name	Application Name	IP Address	Computer Name	Ports to Open	Schedule	Inbound Filter
<input type="checkbox"/>		<< Application Name	0.0.0.0	<< Computer Name	TCP 0	Always	Allow All
<input type="checkbox"/>		<< Application Name	0.0.0.0	<< Computer Name	UDP 0	Always	Allow All
<input type="checkbox"/>		<< Application Name	0.0.0.0	<< Computer Name	TCP 0	Always	Allow All
<input type="checkbox"/>		<< Application Name	0.0.0.0	<< Computer Name	UDP 0	Always	Allow All

Helpful Hints ...

Check the **Application Name** drop down menu for a list of predefined applications. If you select one of the predefined applications, click the arrow button next to the drop down menu to fill out the corresponding field.

You can select a computer from the list of DHCP clients in the **Computer Name** drop down menu, or you can manually enter the IP address of the LAN computer to which you would like to open the specified port.

Select a schedule for when the rule will be enabled. If you do not see the schedule you need in the list of

Application Rules

Some applications require multiple connections, such as Internet gaming, video conferencing, Internet telephony and others. These applications have difficulties working through NAT (Network Address Translation). Special Applications makes some of these applications work with the DIR-826L. If you need to run applications that require multiple connections, specify the port normally associated with an application in the "Trigger Port" field, select the protocol type as TCP or UDP, then enter the firewall (public) ports associated with the trigger port to open them for inbound traffic.

The DIR-826L provides some predefined applications in the table on the bottom of the web page. Select the application you want to use and enable it.

Name: Enter a name for the rule. You may select a pre-defined application from the drop-down menu and click <<.

Trigger: This is the port used to trigger the application. It can be either a single port or a range of ports.

Traffic Type: Select the protocol of the trigger port (TCP, UDP, or Both).

Firewall: This is the port number on the Internet side that will be used to access the application. You may define a single port or a range of ports. You can use a comma to add multiple ports or port ranges.

Traffic Type: Select the protocol of the firewall port (TCP, UDP, or Both).

Schedule: The schedule of time when the Application Rule will be enabled. The schedule may be set to Always, which will allow the particular service to always be enabled. You can create your own times in the **Tools > Schedules** section.

D-Link

DIR-826L // SETUP ADVANCED TOOLS STATUS SUPPORT

APPLICATION RULES

This option is used to open single or multiple ports on your router when the router senses data sent to the Internet on a "trigger" port or port range. Special Applications rules apply to all computers on your internal network.

Save Settings Don't Save Settings

24— APPLICATION RULES

	Name	Application	Trigger	Firewall	Traffic Type	Schedule
<input type="checkbox"/>	<input type="text"/>	<< Application Name	0	0	TCP	Always
<input type="checkbox"/>	<input type="text"/>	<< Application Name	0	0	TCP	Always
<input type="checkbox"/>	<input type="text"/>	<< Application Name	0	0	TCP	Always

Helpful Hints...

Use this feature if you are trying to execute one of the listed network applications and it is not communicating as expected.

Check the **Application Name** drop down menu for a list of predefined applications. If you select one of the predefined applications, click the arrow button next to the drop down menu to fill out the corresponding field.

Select a schedule for when the service will be enabled. If you do not see the schedule you need in the list of schedules, go to the [Tools > Schedules](#)

QoS Engine

The QoS Engine option helps improve your network gaming performance by prioritizing applications. By default the QoS Engine settings are disabled and application priority is not classified automatically.

Enable QoS Engine: This option is disabled by default. Enable this option for better performance and experience with online games and other interactive applications, such as VoIP.

Automatic Uplink

Speed: This option is enabled by default when the QoS Engine option is enabled. This option will allow your router to automatically determine the uplink speed of your Internet connection.

Measured Uplink Speed: This displays the detected uplink speed.

Manual Uplink Speed: The speed at which data can be transferred from the router to your ISP. This is determined by your ISP. ISP's often speed as a download/upload pair. For example, 1.5Mbps/284Kbits. Using this example, you would enter 284. Alternatively you can test your uplink speed with a service such as speedtest.net.

QoS Engine Rules: A QoS Engine Rule identifies a specific message flow and assigns a priority to that flow. For most applications, automatic classification will be adequate, and specific QoS Engine Rules will not be required.

The QoS Engine supports overlaps between rules, where more than one rule can match for a specific message flow. If more than one rule is found to match the rule with the highest priority will be used.

Name: Create a name for the rule that is meaningful to you.

Priority: The priority of the message flow is entered here -- 1 receives the highest priority (most urgent) and 255 receives the lowest priority (least urgent).

Protocol: The protocol used by the messages.

Local IP Range: The rule applies to a flow of messages whose LAN-side IP address falls within the range set here.

Local Port Range: The rule applies to a flow of messages whose LAN-side port number is within the range set here.

Remote IP Range: The rule applies to a flow of messages whose WAN-side IP address falls within the range set here.

Remote Port Range: The rule applies to a flow of messages whose WAN-side port number is within the range set here.

QOS ENGINE SETUP	
Enable QoS Engine :	<input type="checkbox"/>
Automatic Uplink Speed :	<input checked="" type="checkbox"/>
Measured Uplink Speed :	Not Estimated
Manual Uplink Speed :	128 kbps << <input type="text" value="Select Transmission Rate"/>

10 -- QOS ENGINE RULES		
<input type="checkbox"/>	Name <input type="text"/>	Priority 1 (1..255)
	Local IP Range 0.0.0.0 to 255.255.255.255	Local Port Range 0 to 65535
	Remote IP Range 0.0.0.0 to 255.255.255.255	Remote Port Range 0 to 65535
<input type="checkbox"/>	Name <input type="text"/>	Priority 1 (1..255)
	Local IP Range 0.0.0.0 to 255.255.255.255	Local Port Range 0 to 65535
	Remote IP Range 0.0.0.0 to 255.255.255.255	Remote Port Range 0 to 65535

Network Filters

Use MAC (Media Access Control) Filters to allow or deny LAN (Local Area Network) computers by their MAC addresses from accessing the network. You can either manually add a MAC address or select the MAC address from the list of clients that are currently connected to the Broadband Router.

Configure MAC Filtering: Select **Turn MAC Filtering Off, Allow MAC addresses listed below**, or **Deny MAC addresses listed below** from the drop-down menu.

MAC Address: Enter the MAC address you would like to filter.

To find the MAC address on a computer, please refer to the *Networking Basics* section in this manual.

DHCP Client: Select a DHCP client from the drop-down menu and click << to copy that MAC Address.

Clear: Click to remove the MAC address.

D-Link

DIR-826L // SETUP ADVANCED TOOLS STATUS SUPPORT

MAC ADDRESS FILTER

The MAC (Media Access Controller) Address filter option is used to control network access based on the MAC Address of the network adapter. A MAC address is a unique ID assigned by the manufacturer of the network adapter. This feature can be configured to ALLOW or DENY network/Internet access.

Save Settings Don't Save Settings

24 --- MAC FILTERING RULES

Configure MAC Filtering below:
Turn MAC Filtering OFF

MAC Address		DHCP Client List	
00:00:00:00:00:00	<<	Computer Name	Clear
00:00:00:00:00:00	<<	Computer Name	Clear
00:00:00:00:00:00	<<	Computer Name	Clear
00:00:00:00:00:00	<<	Computer Name	Clear
00:00:00:00:00:00	<<	Computer Name	Clear
00:00:00:00:00:00	<<	Computer Name	Clear
00:00:00:00:00:00	<<	Computer Name	Clear

Helpful Hints...

Create a list of MAC addresses that you would either like to allow or deny access to your network.

Computers that have obtained an IP address from the router's DHCP server will be in the DHCP Client List. Select a device from the drop down menu, then click the arrow to add that device's MAC address to the list.

Click the **Clear** button to remove the MAC address from the MAC Filtering list.

[More...](#)

Access Control

The Access Control section allows you to control access in and out of your network. Use this feature as Parental Controls to only grant access to approved sites, limit web access based on time or dates, and/or block access from applications like P2P utilities or games.

Add Policy: Click the **Add Policy** button to start the Access Control Wizard.

D-Link

DIR-826L // SETUP ADVANCED TOOLS STATUS SUPPORT

ACCESS CONTROL

The Access Control option allows you to control access in and out of your network. Use this feature as Access Controls to only grant access to approved sites, limit web access based on time or dates, and/or block internet access for applications like P2P utilities or games.

Save Settings Don't Save Settings

ACCESS CONTROL

Enable Access Control:

Add Policy

POLICY TABLE

Enable Policy	Machine	Filtering	Logged	Schedule

Helpful Hints...

Check **Enable Access Control** if you want to enforce rules that limit Internet access from specific LAN computers.

Click **Add Policy** to start the processes of creating a rule. You can cancel the process at any time. When you are finished creating a rule it will be added to the **Policy Table** below.

Click the **Edit** icon to modify an existing rule using the Policy Wizard.

Click the **Delete** icon to permanently remove a rule.

Access Control Wizard

Click **Next** to continue with the wizard.

ADD NEW POLICY

This wizard will guide you through the following steps to add a new policy for Access Control.

Step 1 - Choose a unique name for your policy
 Step 2 - Select a schedule
 Step 3 - Select the machine to which this policy applies
 Step 4 - Select filtering method
 Step 5 - Select filters
 Step 6 - Configure Web Access Logging

Prev Next Save Cancel

Enter a name for the policy and then click **Next** to continue.

STEP 1: CHOOSE POLICY NAME

Choose a unique name for your policy.

Policy Name :

Select a schedule (I.E. Always) from the drop-down menu and then click **Next** to continue.

STEP 2: SELECT SCHEDULE

Choose a schedule to apply to this policy.

Details :

Enter the following information and then click **Next** to continue.

- **Address Type** - Select IP address, MAC address, or Other Machines.
- **IP Address** - Enter the IP address of the computer you want to apply the rule to.
- **Machine Address** - Enter the PC MAC address (i.e. 00:00.00.00.00).

STEP 3: SELECT MACHINE

Select the machine to which this policy applies.

Specify a machine with its IP or MAC address, or select "Other Machines" for machines that do not have a policy.

Address Type : IP MAC Other Machines

IP Address : <<

Machine Address : <<

Machine	IP	MAC
192.168.0.112		

Select the filtering method and then click **Next** to continue.

STEP 4: SELECT FILTERING METHOD

Select the method for filtering.

Method : Log Web Access Only Block All Access Block Some Access

Apply Web Filter :

Apply Advanced Port Filters :

Enter the rule:

Enable - Check to enable the rule.

Name - Enter a name for your rule.

Dest IP Start - Enter the starting IP address.

Dest IP End - Enter the ending IP address.

Protocol - Select the protocol.

Dest Port Start - Enter the starting port number.

Dest Port End - Enter the ending port number.

STEP 5: PORT FILTER

Add Port Filters Rules.

Specify rules to prohibit access to specific IP addresses and ports.

Enable	Name	Dest IP Start	Dest IP End	Protocol	Dest Port Start	Dest Port End
<input type="checkbox"/>		0.0.0.0	255.255.255.255	Any	0	65535
<input type="checkbox"/>		0.0.0.0	255.255.255.255	Any	0	65535
<input type="checkbox"/>		0.0.0.0	255.255.255.255	Any	0	65535
<input type="checkbox"/>		0.0.0.0	255.255.255.255	Any	0	65535
<input type="checkbox"/>		0.0.0.0	255.255.255.255	Any	0	65535
<input type="checkbox"/>		0.0.0.0	255.255.255.255	Any	0	65535
<input type="checkbox"/>		0.0.0.0	255.255.255.255	Any	0	65535
<input type="checkbox"/>		0.0.0.0	255.255.255.255	Any	0	65535

Prev Next Save Cancel

To enable web logging, click **Enable**.

Click **Save** to save the access control rule.

STEP 6: CONFIGURE WEB ACCESS LOGGING

Web Access Logging : Disabled
 Enable

Prev Next Save Cancel

Your newly created policy will now show up under **Policy Table**.

ACCESS CONTROL

The Access Control option allows you to control access in and out of your network. Use this feature as Access Controls to only grant access to approved sites, limit web access based on time or dates, and/or block internet access for applications like P2P utilities or games.

Save Settings Don't Save Settings Reboot Now

ENABLE

Enable Access Control :

Add Policy

POLICY TABLE

Enable Policy	Machine	Filtering	Logged	Schedule		
<input checked="" type="checkbox"/>	dlink	192.168.0.106	Block Some Access	No	Always	

Website Filters

Website Filters are used to allow you to set up a list of Web sites that can be viewed by multiple users through the network. To use this feature select to **Allow** or **Deny**, enter the domain or website and click **Save Settings**. You must also select **Apply Web Filter** under the *Access Control* section.

Add Website Select either **DENY computers access to ONLY Filtering Rule: these sites** or **ALLOW computers access to ONLY these sites**.

Website URL/ Domain: Enter the keywords or URLs that you want to allow or block. Click **Save Settings**.

The screenshot displays the D-Link DIR-826L web interface. The top navigation bar includes tabs for SETUP, ADVANCED, TOOLS, STATUS, and SUPPORT. The left sidebar lists various configuration options, with WEBSITE FILTER selected. The main content area is titled 'WEBSITE FILTER' and contains the following elements:

- WEBSITE FILTER** (Section Header)
- Text: "The Website Filter option allows you to set up a list of Web sites you would like to allow or deny through your network. To use this feature, you must also select the 'Apply Web Filter' checkbox in the Access Control section."
- Buttons: "Save Settings" and "Don't Save Settings"
- 40 - WEBSITE FILTERING RULES** (Section Header)
- Text: "Configure Website Filter below:"
- Dropdown menu: "DENY computers access to ONLY these sites"
- Button: "Clear the list below..."
- Table with 2 columns: "Website URL/Domain" (with 6 empty input fields).

On the right side of the interface, there is a "Helpful Hints..." section with the text: "Create a list of Web Sites to which you would like to deny or allow through the network." and a link: "Use with Advanced → Access Control." Below this is a "More..." link.

Inbound Filters

The Inbound Filter option is an advanced method of controlling data received from the Internet. With this feature you can configure inbound data filtering rules that control data based on an IP address range. Inbound Filters can be used with Virtual Server, Port Forwarding, or Remote Administration features.

Name: Enter a name for the inbound filter rule.

Action: Select **Allow** or **Deny**.

Enable: Check to enable rule.

Remote IP Start: Enter the starting IP address. Enter 0.0.0.0 if you do not want to specify an IP range.

Remote IP End: Enter the ending IP address. Enter 255.255.255.255 if you do not want to specify and IP range.

Add: Click the **Add** button to apply your settings. You must click **Save Settings** at the top to save the settings.

Inbound Filter Rules List: This section will list any rules that are created. You may click the **Edit** icon to change the settings or enable/disable the rule, or click the **Delete** icon to remove the rule.

D-Link

DIR-826L // SETUP ADVANCED TOOLS STATUS SUPPORT

INBOUND FILTER

The Inbound Filter option is an advanced method of controlling data received from the Internet. With this feature you can configure inbound data filtering rules that control data based on an IP address range.

Inbound Filters can be used for limiting access to a server on your network to a system or group of systems. Filter rules can be used with Virtual Server, Port Forwarding, or Remote Administration features.

ADD INBOUND FILTER RULE

Name :

Action : **Allow**

Remote IP Range :	Enable	Remote IP Start	Remote IP End
<input type="checkbox"/>	<input type="checkbox"/>	0.0.0.0	255.255.255.255
<input type="checkbox"/>	<input type="checkbox"/>	0.0.0.0	255.255.255.255
<input type="checkbox"/>	<input type="checkbox"/>	0.0.0.0	255.255.255.255
<input type="checkbox"/>	<input type="checkbox"/>	0.0.0.0	255.255.255.255
<input type="checkbox"/>	<input type="checkbox"/>	0.0.0.0	255.255.255.255
<input type="checkbox"/>	<input type="checkbox"/>	0.0.0.0	255.255.255.255
<input type="checkbox"/>	<input type="checkbox"/>	0.0.0.0	255.255.255.255
<input type="checkbox"/>	<input type="checkbox"/>	0.0.0.0	255.255.255.255
<input type="checkbox"/>	<input type="checkbox"/>	0.0.0.0	255.255.255.255

INBOUND FILTER RULES LIST

Name	Action	Remote IP Range		

Helpful Hints ...

Give each rule a **Name** that is meaningful to you.

Each rule can either **Allow** or **Deny** access from the WAN.

Up to eight ranges of WAN IP addresses can be controlled by each rule. The checkbox by each IP range can be used to disable ranges already defined.

The starting and ending IP addresses are WAN-side address.

Click the **Add** or **Update** button to store a finished rule in the Rules List below.

Click the **Edit** icon in the Rules List to change a rule.

Click the **Delete** icon in the Rules List to permanently remove a rule.

[More...](#)

WIRELESS

Firewall Settings

A firewall protects your network from the outside world. The DIR-826L offers a firewall type functionality. The SPI feature helps prevent cyber attacks. Sometimes you may want a computer exposed to the outside world for certain types of applications. If you choose to expose a computer, you can enable DMZ. DMZ is short for Demilitarized Zone. This option will expose the chosen computer completely to the outside world.

Enable SPI: SPI (Stateful Packet Inspection, also known as dynamic packet filtering) helps to prevent cyber attacks by tracking more state per session. It validates that the traffic passing through the session conforms to the protocol.

Anti-Spoof Check: Enable this feature to protect your network from certain kinds of “spoofing” attacks.

Enable DMZ: If an application has trouble working from behind the router, you can expose one computer to the Internet and run the application on that computer.

Note: *Placing a computer in the DMZ may expose that computer to a variety of security risks. Use of this option is only recommended as a last resort.*

DMZ IP Address: Specify the IP address of the computer on the LAN that you want to have unrestricted Internet communication. If this computer obtains its IP address automatically using DHCP, be sure to make a static reservation on the **Setup > Network Settings** page so that the IP address of the DMZ machine does not change.

PPTP: Allows multiple machines on the LAN to connect to their corporate network using PPTP protocol.

IPSEC (VPN): Allows multiple VPN clients to connect to their corporate network using IPsec. Some VPN clients support traversal of IPsec through NAT. This ALG may interfere with the operation of such VPN clients. If you are having trouble connecting with your corporate network, try turning this ALG off. Please check with the system administrator of your corporate network whether your VPN client supports NAT traversal.

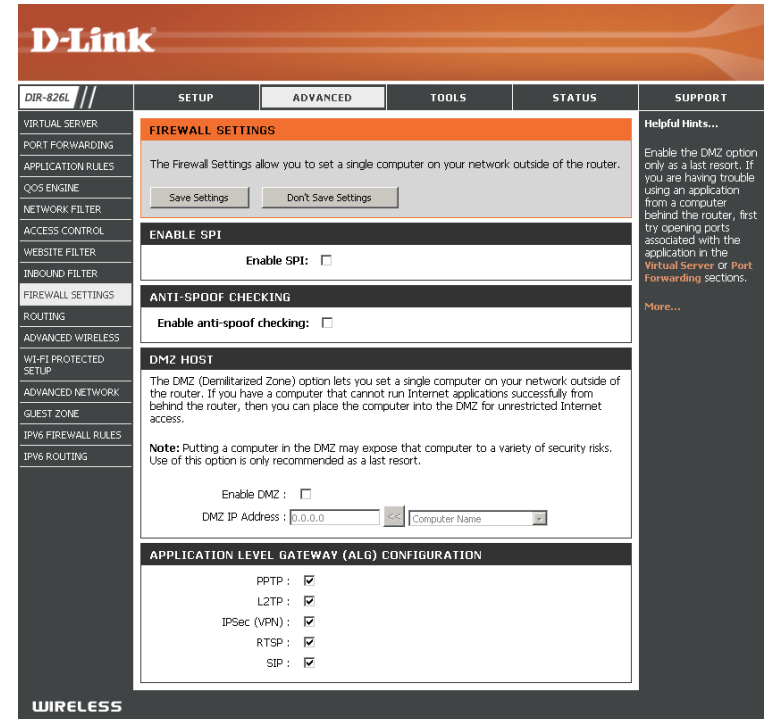

RTSP: Allows application that uses Real Time Streaming Protocol to receive streaming media from the Internet. QuickTime and Real Player are some of the common applications using this protocol.

SIP: Allows devices and applications using VoIP (Voice over IP) to communicate across NAT. Some VoIP applications and devices have the ability to discover NAT devices and work around them. This ALG may interfere with the operation of such devices. If you are having trouble making VoIP calls, try turning this ALG off.

Routing

The Routing option is an advanced method of customizing specific routes of data through your network.

Name: Enter a name for your route.

Destination IP: Enter the IP address of packets that will take this route.

Netmask: Enter the netmask of the route, please note that the octets must match your destination IP address.

Gateway: Enter your next hop gateway to be taken if this route is used.

Metric: The route metric is a value from 1 to 16 that indicates the cost of using this route. A value 1 is the lowest cost and 15 is the highest cost.

Interface: Select the interface that the IP packet must use to transit out of the router when this route is used.

D-Link

DIR-826L

SETUP ADVANCED TOOLS STATUS SUPPORT

ROUTING :

This Routing page allows you to specify custom routes that determine how data is moved around your network.

Save Settings Don't Save Settings

32 --ROUTE LIST

	Name	Destination IP	Metric	Interface
<input type="checkbox"/>	<input type="text"/>	<input type="text" value="0.0.0.0"/>	<input type="text" value="1"/>	<input type="text" value="WAN"/>
	Netmask	Gateway		
	<input type="text" value="0.0.0.0"/>	<input type="text" value="0.0.0.0"/>		
<input type="checkbox"/>	<input type="text"/>	<input type="text" value="0.0.0.0"/>	<input type="text" value="1"/>	<input type="text" value="WAN"/>
	Netmask	Gateway		
	<input type="text" value="0.0.0.0"/>	<input type="text" value="0.0.0.0"/>		
<input type="checkbox"/>	<input type="text"/>	<input type="text" value="0.0.0.0"/>	<input type="text" value="1"/>	<input type="text" value="WAN"/>
	Netmask	Gateway		
	<input type="text" value="0.0.0.0"/>	<input type="text" value="0.0.0.0"/>		

Helpful Hints...

Each route has a check box next to it, check this box if you want the route to be enabled.

The name field allows you to specify a name for identification of this route, e.g. 'Network 2'

The destination IP address is the address of the host or network you wish to reach.

The netmask field identifies the portion of the destination IP in use.

The gateway IP address is the IP address of the router, if any, used to reach the specified destination.

[More...](#)

Advanced Wireless

Transmit Power: Set the transmit power of the antennas.

WLAN Partition: This enables 802.11d operation. 802.11d is a wireless specification developed to allow implementation of wireless networks in countries that cannot use the 802.11 standard. This feature should only be enabled if you are in a country that requires it.

WMM Enable: WMM is QoS for your wireless network. This will improve the quality of video and voice applications for your wireless clients.

Short GI: Check this box to reduce the guard interval time therefore increasing the data capacity. However, it's less reliable and may create higher data loss.

HT20/40 Coexistence: Enable this option to reduce interference from other wireless networks in your area. If the channel width is operating at 40MHz and there is another wireless network's channel over-lapping and causing interference, the router will automatically change to 20MHz.

D-Link

DIR-826L // SETUP ADVANCED TOOLS STATUS SUPPORT

ADVANCED WIRELESS

If you are not familiar with these Advanced Wireless settings, please read the help section before attempting to modify these settings.

Save Settings Don't Save Settings

ADVANCED WIRELESS SETTINGS

Wireless Band : 2.4GHz
 Transmit Power : High
 WLAN Partition :
 WMM Enable :
 Short GI :
 HT 20/40 MHz Coexistence : Enable Disable

ADVANCED WIRELESS SETTINGS

Wireless Band : 5GHz
 Transmit Power : High
 WLAN Partition :
 WMM Enable :
 Short GI :

Helpful Hints ...

It is recommended that you leave these parameters at their default values. Adjusting them could limit the performance of your wireless network.

Enabling WMM can help control latency and jitter when transmitting multimedia content over a wireless connection.

[More...](#)

WIRELESS

Wi-Fi Protected Setup (WPS)

Wi-Fi Protected Setup (WPS) System is a simplified method for securing your wireless network during the “Initial setup” as well as the “Add New Device” processes. The Wi-Fi Alliance (WFA) has certified it across different products as well as manufactures. The process is just as easy as pressing a button for the Push-Button Method or correctly entering the 8-digit code for the Pin Code Method. The time reduction in setup and ease of use are quite beneficial, while the highest wireless Security setting of WPA2 is automatically used.

Enable: Enable the Wi-Fi Protected Setup feature.

Note: if this option is unchecked, the WPS button on the side of the router will be disabled.

Disable WPS-PIN Method: Check to disable the WPS PIN method of securing your network. This will not affect the Push-Button method.

PIN Settings: A PIN is a unique number that can be used to add the router to an existing network or to create a new network. Only the Administrator (“admin” account) can change or reset the PIN.

Current PIN: Shows the current PIN.

Reset PIN to Default: Restore the default PIN of the router.

Generate New PIN: Create a random number that is a valid PIN. This becomes the router’s PIN. You can then copy this PIN to the user interface of the wireless client.

The screenshot shows the D-Link router's web interface for the Wi-Fi Protected Setup (WPS) configuration. The main content area is divided into three sections:

- WI-FI PROTECTED SETUP:** Contains a description of WPS and two buttons: "Save Settings" and "Don't Save Settings".
- WI-FI PROTECTED SETUP (Configuration):** Shows "Enable" checked with a checkbox, "Disable WPS-PIN Method" unchecked with a checkbox, and a "Reset to Unconfigured" button.
- PIN SETTINGS:** Shows "Current PIN" as 12345678, with "Generate New PIN" and "Reset PIN to Default" buttons.
- ADD WIRELESS STATION:** Contains an "Add Wireless Device Wizard" button.

The left sidebar lists various configuration options, with "WI-FI PROTECTED SETUP" highlighted. The right sidebar contains "Helpful Hints..." and "Lock Wireless Security Settings" information.

Add Wireless Station: This Wizard helps you add wireless devices to the wireless network.

The wizard will either display the wireless network settings to guide you through manual configuration, prompt you to enter the PIN for the device, or ask you to press the configuration button on the device. If the device supports Wi-Fi Protected Setup and has a configuration button, you can add it to the network by pressing the configuration button on the device and then the on the router within 60 seconds. The status LED on the router will flash three times if the device has been successfully added to the network.

There are several ways to add a wireless device to your network. A “registrar” controls access to the wireless network. A registrar only allows devices onto the wireless network if you have entered the PIN, or pressed a special Wi-Fi Protected Setup button on the device. The router acts as a registrar for the network, although other devices may act as a registrar as well.

Add Wireless Device Wizard: Click to start the wizard and skip to page 44.

WPS Button

You can also simply press the WPS button on the side of the router, and then press the WPS button on your wireless client to automatically connect without logging into the router.

Refer to page 109 for more information.

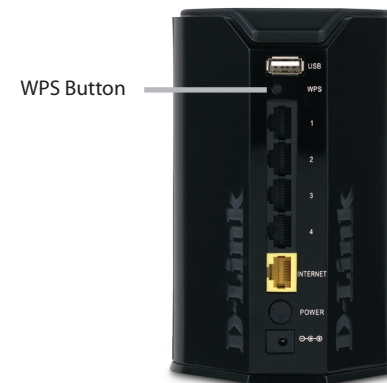

Advanced Network Settings

Enable UPnP: To use the Universal Plug and Play (UPnP™) feature click on **Enabled**. UPnP provides compatibility with networking equipment, software and peripherals.

WAN Ping: Checking the box will allow the DIR-826L to respond to pings. Unchecking the box may provide some extra security from hackers.

WAN Ping Inbound Filter: Select from the drop-down menu if you would like to apply the Inbound Filter to the WAN ping. Refer to the Inbound Filters section for more information.

WAN Port Speed: You may set the port speed of the Internet port to 10Mbps, 100Mbps, 1000Mbps, or Auto (recommended).

Enable IPv4 Multicast Streams: Check the box to allow multicast traffic to pass through the router from the Internet (IPv4).

Enable IPv6 Multicast Streams: Check the box to allow multicast traffic to pass through the router from the Internet (IPv6).

The screenshot displays the 'Advanced Network' settings for a D-Link DIR-826L router. The interface includes a navigation menu on the left with options like 'VIRTUAL SERVER', 'PORT FORWARDING', and 'ADVANCED NETWORK'. The main content area is divided into several sections:

- ADVANCED NETWORK:** A warning message states, 'If you are not familiar with these Advanced Network settings, please read the help section before attempting to modify these settings.' Below this are 'Save Settings' and 'Don't Save Settings' buttons.
- UPNP:** The 'Universal Plug and Play (UPnP) supports peer-to-peer Plug and Play functionality for network devices.' The 'Enable UPnP' checkbox is checked.
- WAN PING:** A message says, 'If you enable this feature, the WAN port of your router will respond to ping requests from the Internet that are sent to the WAN IP Address.' The 'Enable WAN Ping Respond' checkbox is unchecked. The 'WAN Ping Inbound Filter' is set to 'Allow All'.
- WAN PORT SPEED:** The 'WAN Port Speed' is set to '100Mbps'.
- IPV4 MULTICAST STREAMS:** The 'Enable IPv4 Multicast Streams' checkbox is unchecked.
- IPV6 MULTICAST STREAMS:** The 'Enable IPv6 Multicast Streams' checkbox is checked.

On the right side, there is a 'Helpful Hints ...' section with additional information about UPnP and WAN speed. The 'WIRELESS' logo is visible at the bottom left of the page.

Guest Zone

The Guest Zone feature will allow you to create temporary zones that can be used by guests to access the Internet. These zones will be separate from your main wireless network. You may configure different zones for the 2.4GHz and 5GHz wireless bands.

Enable Guest Zone: Check to enable the Guest Zone feature.

Schedule: The schedule of time when the Guest Zone will be active. The schedule may be set to **Always**, which will allow the particular service to always be enabled. You can create your own times in the **Tools > Schedules** section or click **Add New**.

Wireless Network Name: Enter a wireless network name (SSID) that is different from your main wireless network.

Enable Routing Between Zones: Check to allow network connectivity between the different zones created.

Security Mode: Select the type of security or encryption you would like to enable for the guest zone.

The screenshot displays the D-Link DIR-826L web interface. The top navigation bar includes 'DIR-826L', 'SETUP', 'ADVANCED', 'TOOLS', 'STATUS', and 'SUPPORT'. The 'GUEST ZONE' section is highlighted in orange. Below the header, there is a 'GUEST ZONE SELECTION' section for the 2.4GHz band and another for the 5GHz band. Each section contains the following fields:

- Enable Guest Zone:** A checkbox that is currently unchecked.
- Wireless Band:** A dropdown menu set to 'Always' with an 'Add New' button next to it.
- Wireless Network Name:** A text input field containing 'dlink_guest' for the 2.4GHz band and 'dlink_media_guest' for the 5GHz band. A note indicates '(Also called the SSID)'.
- Enable Routing Between Zones:** A checkbox that is currently unchecked.

At the bottom of the page, the 'WIRELESS' section is visible. On the right side, there is a 'Helpful Hints...' section with text explaining the purpose of the guest zone settings.

IPv6 Firewall

The DIR-826L's IPv6 Firewall feature allows you to configure which kind of IPv6 traffic is allowed to pass through the device. The DIR-826L's IPv6 Firewall functions in a similar way to the IP Filters feature.

Enable Checkbox: Check the box to enable the IPv6 firewall simple security.

Configure IPv6 Firewall: Select an action from the drop-down menu.

Name: Enter a name to identify the IPv6 firewall rule.

Schedule: Use the drop-down menu to select the time schedule that the IPv6 Firewall Rule will be enabled on. The schedule may be set to **Always**, which will allow the particular service to always be enabled. You can create your own times in the **Tools > Schedules** section.

Source: Use the **Source** drop-down menu to specify the interface that connects to the source IPv6 addresses of the firewall rule.

IP Address Range: Enter the source IPv6 address range in the adjacent **IP Address Range** field.

Dest: Use the **Dest** drop-down menu to specify the interface that connects to the destination IP addresses of the firewall rule.

Protocol: Select the protocol of the firewall port (**All**, **TCP**, **UDP**, or **ICMP**).

Port Range: Enter the first port of the range that will be used for the firewall rule in the first box and enter the last port in the field in the second box.

D-Link

DIR-826L // SETUP ADVANCED TOOLS STATUS SUPPORT

IPv6 FIREWALL RULES

The Firewall Settings section is an advance feature used to allow or deny traffic from passing through the device. It works in the same way as IP Filters with additional settings. You can create more detailed rules for the device.

Save Settings Don't Save Settings

IPv6 SIMPLE RULES

Enable IPv6 Simple Security :

IPv6 FIREWALL RULES

Configure IPv6 Firewall below:
Turn IPv6 Firewall OFF

Remaining number of firewall rules that can be configured:

Name	Schedule	Source	Interface	IP Address Range	Protocol	Port Range	Dest
	Always	<input type="checkbox"/>	*	0:0:0:0:0:0:0:0	TCP	1	65535
			*	0:0:0:0:0:0:0:0			

Helpful Hints ...

Check the **Application Name** drop down menu for a list of predefined server types. If you select one of the predefined server types, click the arrow button next to the drop down menu to fill out the corresponding field.

You can select a computer from the list of DHCP clients in the **Computer Name** drop down menu, or you can manually enter the IP address of the computer at which you would like to open the specified port.

Select a schedule for when the virtual server will be enabled. If you

IPv6 Routing

This page allows you to specify custom routes that determine how data is moved around your network.

Route List: Check the box next to the route you wish to enable.

Name: Enter a specific name to identify this route.

Destination IP/Prefix Length: This is the IP address of the router used to reach the specified destination or enter the IPv6 address prefix length of the packets that will take this route.

Metric: Enter the metric value for this rule here.

Interface: Use the drop-down menu to specify if the IP packet must use the WAN or LAN interface to transit out of the Router.

Gateway: Enter the next hop that will be taken if this route is used.

D-Link

DIR-826L //

SETUP ADVANCED TOOLS STATUS SUPPORT

ROUTING :

This Routing page allows you to specify custom routes that determine how data is moved around your network.

Save Settings Don't Save Settings

10 --ROUTE LIST

Name	Destination IPv6/Prefix Length	Metric	Interface	Gateway
<input type="checkbox"/>	<input type="text" value="0:0:0:0:0:0:0:0 /64"/>	<input type="text" value="0"/>	<input type="text" value="NULL"/>	<input type="text" value="0:0:0:0:0:0:0:0"/>
<input type="checkbox"/>	<input type="text" value="0:0:0:0:0:0:0:0 /64"/>	<input type="text" value="0"/>	<input type="text" value="NULL"/>	<input type="text" value="0:0:0:0:0:0:0:0"/>
<input type="checkbox"/>	<input type="text" value="0:0:0:0:0:0:0:0 /64"/>	<input type="text" value="0"/>	<input type="text" value="NULL"/>	<input type="text" value="0:0:0:0:0:0:0:0"/>
<input type="checkbox"/>	<input type="text" value="0:0:0:0:0:0:0:0 /64"/>	<input type="text" value="0"/>	<input type="text" value="NULL"/>	<input type="text" value="0:0:0:0:0:0:0:0"/>

Helpful Hints ...

Check the **Application Name** drop down menu for a list of predefined server types. If you select one of the predefined server types, click the arrow button next to the drop down menu to fill out the corresponding field.

You can select a computer from the list of DHCP clients in the **Computer Name** drop down menu, or you can manually enter the IP address of the computer at which you would like to open the specified port.

Select a schedule for when the virtual server will be enabled. If you do not see the schedule you need in the list of schedules, go to the **Tools** → **Schedules** screen and create a new schedule.

Tools

Admin

This page will allow you to change the Administrator and User passwords. You can also enable Remote Management. There are two accounts that can access the management interface through the web browser. The accounts are admin and user. Admin has read/write access while user has read-only access. User can only view the settings but cannot make any changes. Only the admin account has the ability to change both admin and user account passwords.

Admin Password: Enter a new password for the Administrator Login Name. The administrator can make changes to the settings.

User Password: Enter the new password for the User login. If you login as the User, you cannot change the settings (you can only view them).

System Name: Enter a name for your router.

Enable Graphical Authentication: Enables a challenge-response test to require users to type letters or numbers from a distorted image displayed on the screen to prevent online hackers and unauthorized users from gaining access to your router's network settings.

Enable HTTPS Server: Check to enable HTTPS to connect to the router securely. This means to connect to the router, you must enter **https://192.168.0.1** (for example) instead of **http://192.168.0.1**.

Enable Remote Management: Remote management allows the DIR-826L to be configured from the Internet by a web browser. A username/password is still required to access the Web Management interface.

Remote Admin Port: The port number used to access the DIR-826L is used in the URL. Example: **http://x.x.x.x:8080** whereas x.x.x.x is the Internet IP address of the DIR-826L and 8080 is the port used for the Web Management interface.

If you have enabled **HTTPS Server**, you must enter **https://** as part of the URL to access the router remotely.

Remote Admin Inbound Filter: This section will list any rules that are created. You may click the **Edit** icon to change the settings or enable/disable the rule, or click the **Delete** icon to remove the rule. **Details** will display the current status.

The screenshot shows the D-Link DIR-826L web management interface. The top navigation bar includes 'D-Link', 'DIR-826L //', and tabs for 'SETUP', 'ADVANCED', 'TOOLS', 'STATUS', and 'SUPPORT'. The 'TOOLS' tab is selected, and the 'ADMIN' sub-tab is active. The main content area is titled 'ADMINISTRATOR SETTINGS' and contains the following sections:

- ADMINISTRATOR SETTINGS:** A text box explaining that 'admin' and 'user' accounts can access the management interface. The admin has read/write access and can change passwords, while the user has read-only access. Below this is a note: 'By default there is no password configured. It is highly recommended that you create a password to keep your router secure.' There are two buttons: 'Save Settings' and 'Don't Save Settings'.
- ADMIN PASSWORD:** A section with the instruction 'Please enter the same password into both boxes, for confirmation.' It contains two input fields: 'Password : [masked]' and 'Verify Password : [masked]'.
- USER PASSWORD:** A section with the instruction 'Please enter the same password into both boxes, for confirmation.' It contains two input fields: 'Password : [masked]' and 'Verify Password : [masked]'.
- SYSTEM NAME:** A section with the label 'Gateway Name :' and an input field containing 'DIR-636L'.
- ADMINISTRATION:** A section with several options:
 - Enable Graphical Authentication :**
 - Enable HTTPS Server :**
 - Enable Remote Management :**
 - Remote Admin Port :** Input field containing '8080' and a 'Use HTTPS' checkbox.
 - Remote Admin Inbound Filter :** A dropdown menu currently set to 'Allow All'.
 - Details :** Input field containing 'Allow All'.

On the right side of the interface, there is a 'Helpful Hints...' section with several tips:

- For security reasons, it is recommended that you change the password for the Admin and User accounts. Be sure to write down the new and passwords to avoid having to reset the router in case they are forgotten.
- Enabling Remote Management, allows you or others to change the router configuration from a computer on the Internet.
- Choose a port to open for remote management.
- Select a filter that controls access as needed for this admin port. If you do not see the filter you need in the list of filters, go to the Advanced - Inbound Filter screen and create a new filter.
- More ...

The bottom left corner of the interface displays the word 'WIRELESS'.

Time

The Time Configuration option allows you to configure, update, and maintain the correct time on the internal system clock. From this section you can set the time zone that you are in and set the Time Server. Daylight Saving can also be configured to automatically adjust the time when needed.

Time: Displays the current date and time of the router.

Time Zone: Select your Time Zone from the drop-down menu.

Enable Daylight Saving: To select Daylight Saving time manually, select **Saving:** enabled or disabled, and enter a start date and an end date for daylight saving time.

Enable NTP Server: NTP is short for Network Time Protocol. A NTP server will synch the time and date with your router. This will only connect to a server on the Internet, not a local server. Check the box to enable this feature.

NTP Server Used: Enter the IP address of a NTP server or select one from the drop-down menu.

Manual: To manually input the time, enter the values in these fields for the Year, Month, Day, Hour, Minute, and Second and then click **Set Time**.

You can also click **Copy Your Computer's Time Settings** to synch the date and time with the computer you are currently on.

The screenshot shows the D-Link DIR-826L web interface. The top navigation bar includes 'DIR-826L //', 'SETUP', 'ADVANCED', 'TOOLS', 'STATUS', and 'SUPPORT'. The left sidebar lists menu items: ADMIN, TIME (selected), SYSLOG, EMAIL SETTINGS, SYSTEM, FIRMWARE, DYNAMIC DNS, SYSTEM CHECK, and SCHEDULES. The main content area is titled 'TIME' and contains the following text: 'The Time Configuration option allows you to configure, update, and maintain the correct time on the internal system clock. From this section you can set the time zone that you are in and set the NTP (Network Time Protocol) Server. Daylight Saving can also be configured to automatically adjust the time when needed.' Below this text are 'Save Settings' and 'Don't Save Settings' buttons. The 'TIME CONFIGURATION' section includes: 'Current Router Time : Sat Jan, 1, 2011 00:14:33', 'Time Zone : ((GMT-08:00) Pacific Time (US/Canada), Tijuana', 'Enable Daylight Saving : ', and 'Daylight Saving Dates : DST Start [Jan] [1st] [Sun] [12:00 AM], DST End [Jan] [1st] [Sun] [12:00 AM]'. The 'AUTOMATIC TIME CONFIGURATION' section includes: 'Enable NTP Server : ', 'NTP Server Used : [] << [Select NTP Server]'. The 'SET THE DATE AND TIME MANUALLY' section includes: 'Date And Time : Year [2012] Month [Jan] Day [25] Hour [02] Minute [07] Second [42] PM', and a 'Copy Your Computer's Time Settings' button. The bottom of the page features the 'WIRELESS' logo. The right sidebar contains 'Helpful Hints ...' with the text: 'Good timekeeping is important for accurate logs and scheduled firewall rules.' and a 'More...' link.

SysLog

The Broadband Router keeps a running log of events and activities occurring on the Router. You may send these logs to a SysLog server on your network.

Enable Logging to SysLog Server: Check this box to send the router logs to a SysLog Server.

SysLog Server IP Address: The address of the SysLog server that will be used to send the logs. You may also select your computer from the drop-down menu (only if receiving an IP address from the router via DHCP).

The screenshot shows the D-Link web interface for the DIR-826L router. The top navigation bar includes tabs for SETUP, ADVANCED, TOOLS, STATUS, and SUPPORT. The left sidebar lists various configuration sections: ADMIN, TIME, SYSLOG, EMAIL SETTINGS, SYSTEM, FIRMWARE, DYNAMIC DNS, SYSTEM CHECK, and SCHEDULES. The main content area is titled 'SYSLOG' and contains the following text: 'The SysLog options allow you to send log information to a SysLog Server.' Below this text are two buttons: 'Save Settings' and 'Don't Save Settings'. Underneath is a section titled 'SYSLOG SETTINGS' with the following configuration options:

- Enable Logging To Syslog Server:**
- Syslog Server IP Address:** <<

On the right side of the interface, there is a 'Helpful Hints ...' section with the following text: 'A System Logger (syslog) is a server that collects in one place the logs from different sources. If the LAN includes a syslog server, you can use this option to send the router's logs to that server.' A 'More...' link is located below this text.

Email Settings

The Email feature can be used to send the system log files, router alert messages, and firmware update notification to your email address.

Enable Email Notification: When this option is enabled, router activity logs are emailed to a designated email address.

From Email Address: This email address will appear as the sender when you receive a log file or firmware upgrade notification via email.

To Email Address: Enter the email address where you want the email sent.

SMTP Server Address: Enter the SMTP server address for sending email.

SMTP Server Port: Enter the SMTP port used on the server.

Enable Authentication: Check this box if your SMTP server requires authentication.

Account Name: Enter your account for sending email.

Password: Enter the password associated with the account. Re-type the password associated with the account.

On Log Full: When this option is selected, logs will be sent via email to your account when the log is full.

On Schedule: Selecting this option will send the logs via email according to schedule.

Schedule: This option is enabled when **On Schedule** is selected. You can select a schedule from the list of defined schedules. To create a schedule, go to **Tools > Schedules**.

Real-Time Browsing History: Check to enable browsing history (for mydlink Lite app).

Push Event: Check to enable and select which alerts to be sent to your mobile device (for mydlink Lite app).

Event Trigger: Check to enable event triggering (for mydlink Lite app).

System

This section allows you to manage the router's configuration settings, reboot the router, and restore the router to the factory default settings. Restoring the unit to the factory default settings will erase all settings, including any rules that you've created.

Save Settings to Local Hard Drive: Use this option to save the current router configuration settings to a file on the hard disk of the computer you are using. First, click the **Save** button. A file dialog will appear, allowing you to select a location and file name for the settings.

Load Settings from Local Hard Drive: Use this option to load previously saved router configuration settings. First, use the **Browse** option to find a previously saved file of configuration settings. Then, click the **Load** button to transfer those settings to the router.

Restore to Factory Default Settings: This option will restore all configuration settings back to the settings that were in effect at the time the router was shipped from the factory. Any settings that have not been saved will be lost, including any rules that you have created. If you want to save the current router configuration settings, use the **Save** button above.

Reboot Device: Click to reboot the router.

The screenshot shows the D-Link web interface for the DIR-826L router. The top navigation bar includes 'SETUP', 'ADVANCED', 'TOOLS', 'STATUS', and 'SUPPORT'. The left sidebar lists various configuration sections: ADMIN, TIME, SYSLOG, EMAIL SETTINGS, SYSTEM (highlighted), FIRMWARE, DYNAMIC DNS, SYSTEM CHECK, and SCHEDULES. The main content area is titled 'SYSTEM SETTINGS' and contains the following text and buttons:

SYSTEM SETTINGS

The System Settings section allows you to reboot the device, or restore the router to the factory default settings. Restoring the unit to the factory default settings will erase all settings, including any rules that you have created.

The current system settings can be saved as a file onto the local hard drive. The saved file or any other saved setting file created by device can be uploaded into the unit.

Save To Local Hard Drive:

Load From Local Hard Drive:

Restore To Factory Default:
Restore all settings to the factory defaults.

Reboot The Device:

The right sidebar contains 'Helpful Hints ...' with the following text:

Once your router is configured the way you want it, you can save the configuration settings to a configuration file.

You might need this file so that you can load your configuration later in the event that the router's default settings are restored.

To save the configuration, click the **Save Configuration** button.

[More...](#)

Firmware

You can upgrade the firmware of the access point here. Make sure the firmware you want to use is on the local hard drive of the computer. Click on **Browse** to locate the firmware file to be used for the update. Please check the D-Link support website for firmware updates at <http://support.dlink.com>. You can download firmware upgrades to your hard drive from this site.

Browse: After you have downloaded the new firmware, click **Browse** to locate the firmware update on your hard drive. Click **Upload** to complete the firmware upgrade.

Upload: Once you have a firmware update on your computer, use this option to browse for the file and then upload the information into the access point.

Language Pack

You can change the language of the web UI by uploading available language packs.

Browse: After you have downloaded the new language pack, click **Browse** to locate the language pack file on your hard drive. Click **Upload** to complete the language pack upgrade.

The screenshot displays the D-Link web interface for the DIR-826L router. The top navigation bar includes 'DIR-826L', 'SETUP', 'ADVANCED', 'TOOLS', 'STATUS', and 'SUPPORT'. The left sidebar lists various configuration options, with 'FIRMWARE' selected. The main content area is titled 'FIRMWARE UPDATE' and contains the following information:

- FIRMWARE UPDATE:** A notice stating there may be new firmware for the DIR-826 to improve functionality and performance, with a link to check for updates on the support site.
- Upgrade Instructions:** A paragraph explaining that to upgrade the firmware, the user must locate the upgrade file on the local hard drive and click the 'Upload' button.
- Language Pack Information:** A section titled 'FIRMWARE AND LANGUAGE PACK INFORMATION' showing the current firmware version as 1.00, dated Tue, 16, Mar, 2010. It notes that there is no language pack currently installed and provides a 'Check Now' button to check for the latest version.
- Firmware Upgrade Form:** A section titled 'FIRMWARE UPGRADE' with a note that some firmware upgrades reset configuration options to factory defaults. It includes a text input field for the firmware file name, a 'Browse...' button, and an 'Upload' button.
- Language Pack Upgrade Form:** A section titled 'LANGUAGE PACK UPGRADE' with a text input field for the language pack file name, a 'Browse...' button, and an 'Upload' button.

The right sidebar contains 'Helpful Hints' regarding firmware updates and a 'More...' link. The bottom of the page features the 'WIRELESS' logo.

Dynamic DNS

The DDNS feature allows you to host a server (Web, FTP, Game Server, etc...) using a domain name that you have purchased (www.whateveryournameis.com) with your dynamically assigned IP address. Most broadband Internet Service Providers assign dynamic (changing) IP addresses. Using a DDNS service provider, your friends can enter in your domain name to connect to your server no matter what your IP address is.

Enable Dynamic DNS: Dynamic Domain Name System is a method of keeping a domain name linked to a changing IP Address. Check the box to enable DDNS.

Server Address: Select your DDNS provider from the drop-down menu or enter the DDNS server address.

Host Name: Enter the Host Name that you registered with your DDNS service provider.

Username or Key: Enter the Username or key for your DDNS account.

Password or Key: Enter the Password or key for your DDNS account.

Timeout: Enter a timeout time (in hours).

Status: Displays the current connection status.

The screenshot shows the D-Link DIR-826L web interface. The top navigation bar includes 'DIR-826L', 'SETUP', 'ADVANCED', 'TOOLS', 'STATUS', and 'SUPPORT'. The left sidebar lists various configuration options: ADMIN, TIME, SYSLOG, EMAIL SETTINGS, SYSTEM, FIRMWARE, DYNAMIC DNS (highlighted), SYSTEM CHECK, and SCHEDULES. The main content area is titled 'DYNAMIC DNS' and contains the following text and form fields:

The DDNS feature allows you to host a server (Web, FTP, Game Server, etc...) using a domain name that you have purchased (www.whateveryournameis.com) with your dynamically assigned IP address. Most broadband Internet Service Providers assign dynamic (changing) IP addresses. Using a DDNS service provider, your friends can enter your host name to connect to your game server no matter what your IP address is.

Sign up for D-Link's Free DDNS service at www.DLinkDDNS.com

Buttons: Save Settings, Don't Save Settings

DYNAMIC DNS

Enable Dynamic DNS :

Server Address : << Select Dynamic DNS Server

Host Name :

Username or Key :

Password or Key :

Verify Password or Key :

Timeout : (hours)

Status : Disconnect

Helpful Hints... To use this feature, you must first have a Dynamic DNS account from one of the providers in the drop down menu. More...

WIRELESS

System Check

Ping Test: The Ping Test is used to send Ping packets to test if a computer is on the Internet. Enter the IP address that you wish to Ping and click **Ping**.

IPv6 Ping Test: Enter the IPv6 address that you wish to Ping and click **Ping**.

Ping Results: The results of your ping attempts will be displayed here.

The screenshot displays the D-Link DIR-826L web interface. The top navigation bar includes 'D-Link' and tabs for 'SETUP', 'ADVANCED', 'TOOLS', 'STATUS', and 'SUPPORT'. The left sidebar lists various configuration options, with 'SYSTEM CHECK' highlighted. The main content area is titled 'PING TEST' and contains the following sections:

- PING TEST**: A section with a description: "Ping Test sends 'ping' packets to test a computer on the Internet." Below this is a form with the label "Host Name or IP Address :" and a text input field, followed by "Ping" and "Stop" buttons.
- IPv6 PING TEST**: A section with a description: "Ping Test sends 'ping' packets to test a computer on the Internet." Below this is a form with the label "Host Name or IPv6 Address :" and a text input field, followed by "Ping" and "Stop" buttons.
- PING RESULT**: A section with the instruction: "Enter a host name or IP address above and click 'Ping'". Below this is a large empty text area for displaying results.

On the right side of the interface, there is a "Helpful Hints ..." section with the following text: "Ping" checks whether a computer on the Internet is running and responding. Enter either the IP address of the target computer or enter its fully qualified domain name. Below this is a "More..." link.

The bottom of the interface features the "WIRELESS" logo.

Schedules

Schedules can be created for use with enforcing rules. For example, if you want to restrict web access to Mon-Fri from 3pm to 8pm, you could create a schedule selecting Mon, Tue, Wed, Thu, and Fri and enter a Start Time of 3pm and End Time of 8pm.

Name: Enter a name for your new schedule.

Days: Select a day, a range of days, or All Week to include every day.

Time: Check **All Day - 24hrs** or enter a start and end time for your schedule.

Save: You must click **Save Settings** at the top for your schedules to go into effect.

Schedule Rules The list of schedules will be listed here. Click the **List:** **Edit** icon to make changes or click the **Delete** icon to remove the schedule.

D-Link

DIR-826L //

SETUP ADVANCED TOOLS STATUS SUPPORT

SCHEDULES

The Schedule configuration option is used to manage schedule rules for various firewall and parental control features.

Save Settings Don't Save Settings

10 - ADD SCHEDULE RULE

Name :

Day(s) : All Week Select Day(s)

Sun Mon Tue Wed Thu Fri Sat

All Day - 24 hrs :

Time format : 12-hour

Start Time : : : PM (hour:minute, 12 hour time)

End Time : : : PM (hour:minute, 12 hour time)

SCHEDULE RULES LIST :

Name :	Day(s) :	Time Frame :	
example	Mon Tue Wed Thu Fri	07:00~23:00	

Helpful Hints ...

Schedules are used with a number of other features to define when those features are in effect.

Give each schedule a name that is meaningful to you. For example, a schedule for Monday through Friday from 3:00pm to 9:00pm, might be called "After School".

Click **Save** to add a completed schedule to the list below.

Click the **Edit** icon to change an existing schedule.

Click the **Delete** icon to permanently delete a schedule.

[More...](#)

WIRELESS

Status

Device Info

This page displays the current information for the DIR-826L. It will display the LAN, WAN (Internet), and Wireless information. If your Internet connection is set up for a Dynamic IP address then a **Release** button and a **Renew** button will be displayed. Use **Release** to disconnect from your ISP and use **Renew** to connect to your ISP.

If your Internet connection is set up for PPPoE, a **Connect** button and a **Disconnect** button will be displayed. Use **Disconnect** to drop the PPPoE connection and use **Connect** to establish the PPPoE connection.

General: Displays the router's time and firmware version.

WAN: Displays the MAC address and the public IP settings

LAN: Displays the MAC address and the private (local) IP settings for the router.

Wireless LAN1: Displays the 2.4GHz wireless MAC address and your wireless settings such as SSID and Channel.

Wireless LAN2: Displays the 5GHz wireless MAC address and your wireless settings such as SSID and Channel.

LAN Computers: Displays computers and devices that are connected to the router via Ethernet and that are receiving an IP address assigned by the router (DHCP).

The screenshot shows the D-Link DIR-826L web interface. The top navigation bar includes tabs for SETUP, ADVANCED, TOOLS, STATUS, and SUPPORT. The left sidebar lists menu items: DEVICE INFO, LOGS, STATISTICS, INTERNET SESSIONS, ROUTING, WIRELESS, IPV6, and IPV6 ROUTING. The main content area is titled 'DEVICE INFORMATION' and contains the following sections:

- GENERAL:** Time: Sunday, January 02, 2011 12:45:08 AM; Firmware Version: 1.00, Tue, 16, Mar, 2010.
- WAN:** Connection Type: Dynamic IP (DHCP); Cable Status: Disconnected; Network Status: Disconnected (with Release and Renew buttons); Connection Up Time: N/A; MAC Address: 00:18:E7:95:70:A1; IP Address: 0.0.0.0; Subnet Mask: 0.0.0.0; Default Gateway: 0.0.0.0; Primary DNS Server: 0.0.0.0; Secondary DNS Server: 0.0.0.0; Advanced DNS: Disabled.
- LAN:** MAC Address: 00:18:E7:95:70:A0; IP Address: 192.168.0.1; Subnet Mask: 255.255.255.0; DHCP Server: Enabled.
- WIRELESS LAN1 (2.4GHz):** Wireless Band: 2.4GHz; Wireless Radio: Enable; 802.11 Mode: 802.11bgn; Channel Width: 20/40MHz; Channel: 2; Wi-Fi Protected Setup: Enabled/Not Configured. SSID List:

Network Name (SSID)	Guest	MAC Address	Security Mode
dlink	No	00:18:E7:95:70:A0	Off
- WIRELESS LAN2 (5GHz):** Wireless Band: 5GHz Band; Wireless Radio: Enable; 802.11 Mode: 802.11n; Channel Width: 20/40MHz; Channel: 36; Wi-Fi Protected Setup: Enabled/Not Configured. SSID List:

Network Name (SSID)	Guest	MAC Address	Security Mode
dlink_media	No	00:18:E7:95:70:A2	Off
- LAN COMPUTERS:**

IP Address	Name (if any)	MAC
192.168.0.100	PM_test01	00:04:23:2C:51:A3
- IGMP MULTICAST MEMBERSHIPS:**

Multicast Group Address

Logs

The router automatically logs (records) events of possible interest in its internal memory. If there isn't enough internal memory for all events, logs of older events are deleted but logs of the latest events are retained. The Logs option allows you to view the router logs. You can define what types of events you want to view and the level of the events to view. This router also has external Syslog Server support so you can send the log files to a computer on your network that is running a Syslog utility.

Log Options: You can select the types of messages that you want to display from the log. System Activity, Debug Information, Attacks, Dropped Packets, and Notice messages can be selected. Click **Apply Log Settings Now** to activate your settings.

Refresh: Updates the log details on the screen so it displays any recent activity.

First Page: Click to go to the first page.

Last Page: Click to go to the last page.

Previous: Click to go back one page.

Next: Click to go to the next page.

Clear: Clears all of the log contents.

Email Now: This option will send a copy of the router log to your email address configured in the **Tools > Email Settings** screen.

Save Log: This option will save the router log to a file on your computer.

D-Link

DIR-826L

SETUP ADVANCED TOOLS STATUS SUPPORT

DEVICE INFO

LOGS

STATISTICS

INTERNET SESSIONS

ROUTING

WIRELESS

IPv6

IPv6 ROUTING

LOGS

Use this option to view the router logs. You can define what types of events you want to view and the event levels to view. This router also has internal syslog server support so you can send the log files to a computer on your network that is running a syslog utility.

LOG OPTIONS

Log Options : System Activity
 Debug Information
 Attacks
 Dropped Packets
 Notice

Apply Log Settings Now

LOG DETAILS

First Page Last Page Previous Next

Refresh Clear Email Now Save Log

1/9

Time	Message
Jan 1 00:19:32	cron.err: crond[11725]: crond (busybox 1.12.1) started, log level 8
Jan 1 00:19:31	cron.err: crond[11673]: crond (busybox 1.12.1) started, log level 8
Jan 1 00:19:30	cron.err: crond[11557]: crond (busybox 1.12.1) started, log level 8
Jan 1 00:19:30	cron.err: crond[11349]: crond (busybox 1.12.1) started, log level 8
Jan 1 00:19:30	user.crit: kernel: Argh. No free space left for GC. nr_erasing_blocks is 0. nr_free_blocks is 0. (erasableempty: yes, erasingempty: yes, erasependingempty: yes)
Jan 1 00:00:24	user.info: kernel: br0: port 2(ra00_0) entering forwarding state
Jan 1 00:00:13	user.info: kernel: br0: port 2(ra00_0) entering learning state
Jan 1 00:00:13	user.info: kernel: br0: port 2(ra00_0) entering learning state
Jan 1 00:00:13	user.info: kernel: device ra00_0 entered promiscuous mode
Jan 1 00:00:13	user.warn: kernel: 0x1300 = 00064380

Helpful Hints...

Check the log frequently to detect unauthorized network usage.

You can also have the log mailed to you periodically. Refer to **Tools -> Email**.

More...

WIRELESS

Statistics

The screen below displays the **Traffic Statistics**. Here you can view the amount of packets that pass through the DIR-826L on both the WAN, LAN ports and the wireless segments. The traffic counter will reset if the device is rebooted.

D-Link

DIR-826L // SETUP ADVANCED TOOLS STATUS SUPPORT

DEVELOPER INFO
LOGS
STATISTICS
INTERNET SESSIONS
ROUTING
WIRELESS
IPV6
IPV6 ROUTING

TRAFFIC STATISTICS
Traffic Statistics display Receive and Transmit packets passing through your router.
Refresh Statistics Clear Statistics

LAN STATISTICS

Sent : 133656	Received : 28232
TX Packets	RX Packets
Dropped : 0	Dropped : 0
Collisions : 0	Errors : 0

WAN STATISTICS

Sent : 66	Received : 0
TX Packets	RX Packets
Dropped : 0	Dropped : 0
Collisions : 0	Errors : 0

WIRELESS STATISTICS

Sent : 17694	Received : 484764
TX Packets	RX Packets
Dropped : 0	Dropped : 0
	Errors : 0

WIRELESS STATISTICS2

Sent : 11865	Received : 7405
TX Packets	RX Packets
Dropped : 0	Dropped : 0
	Errors : 0

Helpful Hints...
This is a summary of the number of packets that have passed between the WAN and the LAN since the router was last initialized.
[More...](#)

WIRELESS

Internet Sessions

The Internet Sessions page displays full details of active Internet sessions through your router. An Internet session is a conversation between a program or application on a LAN-side computer and a program or application on a WAN-side computer.

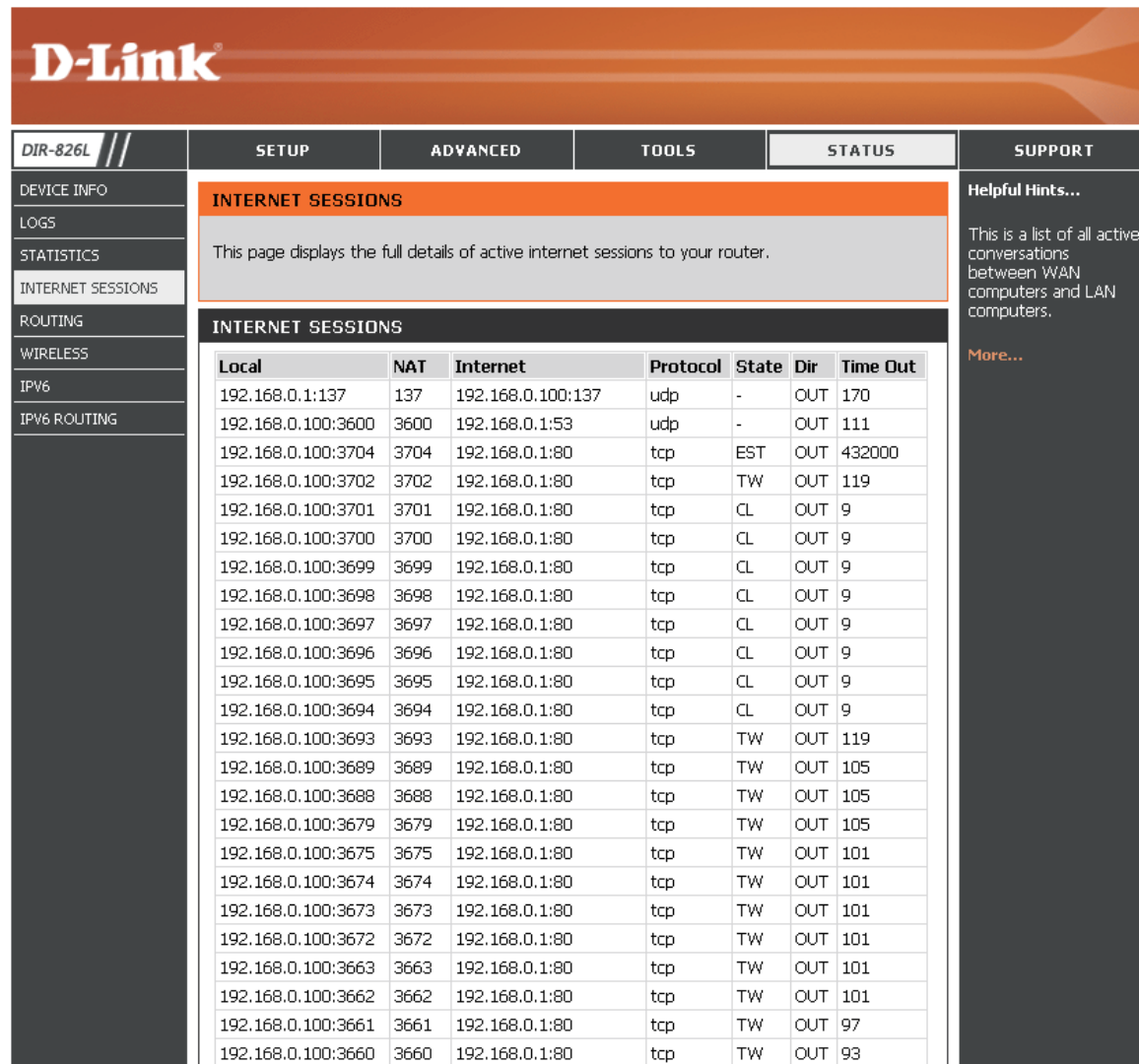

D-Link

DIR-826L //

SETUP ADVANCED TOOLS STATUS SUPPORT

DEVICE INFO
LOGS
STATISTICS
INTERNET SESSIONS
ROUTING
WIRELESS
IPV6
IPV6 ROUTING

INTERNET SESSIONS

This page displays the full details of active internet sessions to your router.

Helpful Hints...

This is a list of all active conversations between WAN computers and LAN computers.

[More...](#)

Local	NAT	Internet	Protocol	State	Dir	Time Out
192.168.0.1:137	137	192.168.0.100:137	udp	-	OUT	170
192.168.0.100:3600	3600	192.168.0.1:53	udp	-	OUT	111
192.168.0.100:3704	3704	192.168.0.1:80	tcp	EST	OUT	432000
192.168.0.100:3702	3702	192.168.0.1:80	tcp	TW	OUT	119
192.168.0.100:3701	3701	192.168.0.1:80	tcp	CL	OUT	9
192.168.0.100:3700	3700	192.168.0.1:80	tcp	CL	OUT	9
192.168.0.100:3699	3699	192.168.0.1:80	tcp	CL	OUT	9
192.168.0.100:3698	3698	192.168.0.1:80	tcp	CL	OUT	9
192.168.0.100:3697	3697	192.168.0.1:80	tcp	CL	OUT	9
192.168.0.100:3696	3696	192.168.0.1:80	tcp	CL	OUT	9
192.168.0.100:3695	3695	192.168.0.1:80	tcp	CL	OUT	9
192.168.0.100:3694	3694	192.168.0.1:80	tcp	CL	OUT	9
192.168.0.100:3693	3693	192.168.0.1:80	tcp	TW	OUT	119
192.168.0.100:3689	3689	192.168.0.1:80	tcp	TW	OUT	105
192.168.0.100:3688	3688	192.168.0.1:80	tcp	TW	OUT	105
192.168.0.100:3679	3679	192.168.0.1:80	tcp	TW	OUT	105
192.168.0.100:3675	3675	192.168.0.1:80	tcp	TW	OUT	101
192.168.0.100:3674	3674	192.168.0.1:80	tcp	TW	OUT	101
192.168.0.100:3673	3673	192.168.0.1:80	tcp	TW	OUT	101
192.168.0.100:3672	3672	192.168.0.1:80	tcp	TW	OUT	101
192.168.0.100:3663	3663	192.168.0.1:80	tcp	TW	OUT	101
192.168.0.100:3662	3662	192.168.0.1:80	tcp	TW	OUT	101
192.168.0.100:3661	3661	192.168.0.1:80	tcp	TW	OUT	97
192.168.0.100:3660	3660	192.168.0.1:80	tcp	TW	OUT	93

Routing

This page will display your current routing table.

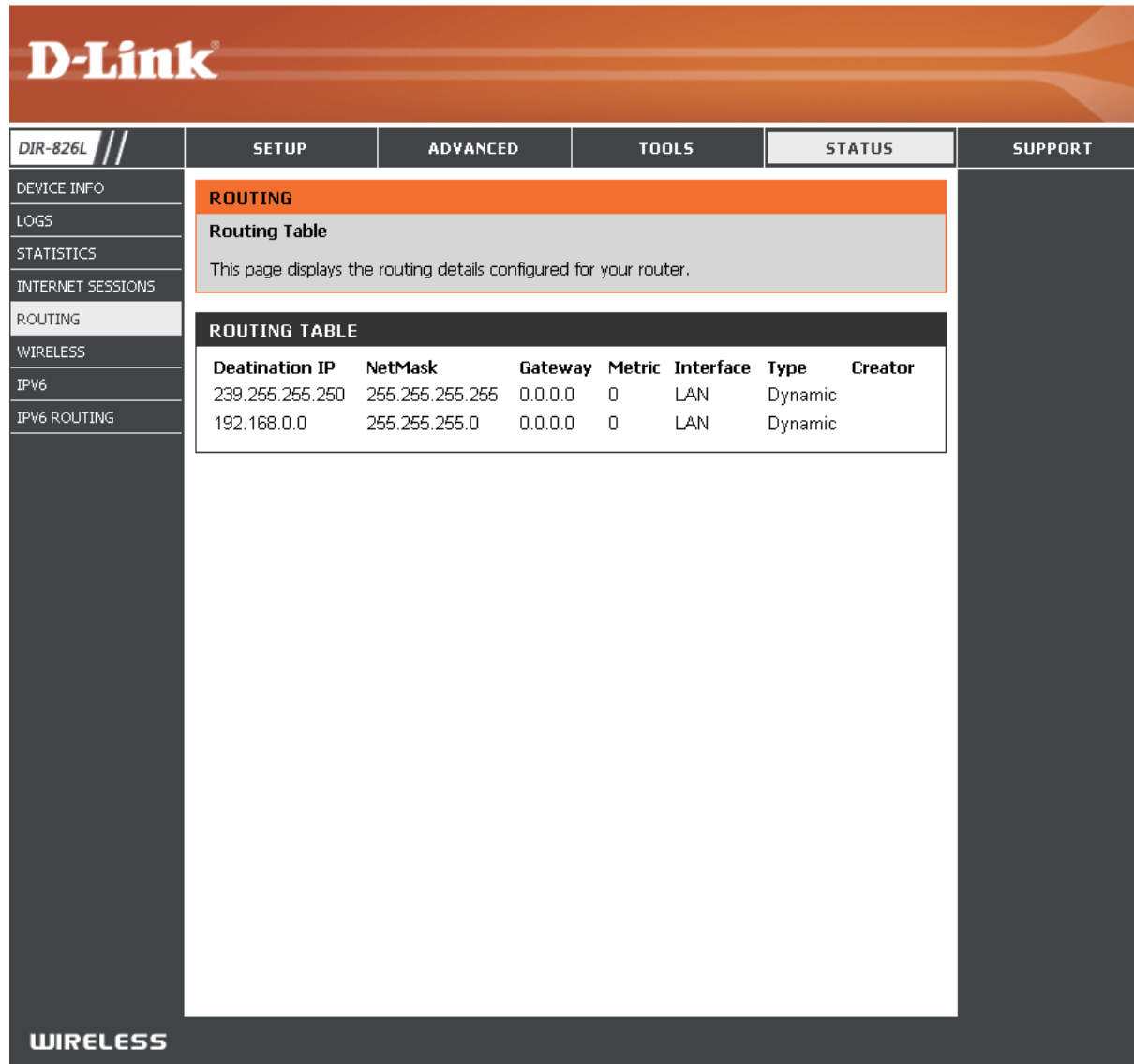

The screenshot shows the D-Link DIR-826L web interface. The top navigation bar includes the D-Link logo and tabs for SETUP, ADVANCED, TOOLS, STATUS, and SUPPORT. The left sidebar contains a menu with options: DEVICE INFO, LOGS, STATISTICS, INTERNET SESSIONS, ROUTING (selected), WIRELESS, IPV6, and IPV6 ROUTING. The main content area is titled "ROUTING" and "Routing Table". It contains a message: "This page displays the routing details configured for your router." Below this is a table titled "ROUTING TABLE" with the following data:

Deatination IP	NetMask	Gateway	Metric	Interface	Type	Creator
239.255.255.250	255.255.255.255	0.0.0.0	0	LAN	Dynamic	
192.168.0.0	255.255.255.0	0.0.0.0	0	LAN	Dynamic	

The bottom of the interface features a "WIRELESS" section header.

Wireless

The wireless client table displays a list of current connected wireless clients. This table also displays the connection time and MAC address of the connected wireless clients.

The screenshot shows the D-Link DIR-826L web interface. The top navigation bar includes tabs for SETUP, ADVANCED, TOOLS, STATUS, and SUPPORT. The left sidebar contains a menu with options: DEVICE INFO, LOGS, STATISTICS, INTERNET SESSIONS, ROUTING, WIRELESS (selected), IPV6, and IPV6 ROUTING. The main content area is titled "WIRELESS" and contains the following information:

Use this option to view the wireless clients that are connected to your wireless router.

NUMBER OF WIRELESS CLIENTS - 2.4GHZ BAND: 0

MAC Address	IP Address	Mode	Rate	Signal (%)

NUMBER OF WIRELESS CLIENTS - 5GHZ BAND: 0

MAC Address	IP Address	Mode	Rate	Signal (%)

At the bottom of the main content area, the word "WIRELESS" is displayed. On the right side, there is a "Helpful Hints..." section with the text: "This is a list of all wireless clients that are currently connected to your wireless router." and a "More..." link.

IPv6

The IPv6 page displays a summary of the Router's IPv6 settings and lists the IPv6 address and host name of any IPv6 clients.

The screenshot displays the IPv6 configuration page for a D-Link DIR-826L router. The page is divided into several sections:

- Navigation:** A top menu bar includes 'DIR-826L', 'SETUP', 'ADVANCED', 'TOOLS', 'STATUS', and 'SUPPORT'. A left sidebar lists various settings: 'DEVICE INFO', 'LOGS', 'STATISTICS', 'INTERNET SESSIONS', 'ROUTING', 'WIRELESS', 'IPv6', and 'IPv6 ROUTING'. The 'WIRELESS' logo is visible at the bottom left.
- IPv6 Network Information:** A summary box stating, 'All of your IPv6 Internet and network connection details are displayed on this page.'
- IPv6 Connection Information:** A detailed box showing:
 - IPv6 Connection Type : Auto Detection
 - Network Status : Disconnected
 - Connection Up Time : N/A
 - Buttons:
 - WAN IPv6 Address :
 - IPv6 IPv6 Default Gateway :
 - LAN IPv6 Address :
 - LAN IPv6 Link-Local Address : fe80:0:0:218:e7ff:fe95:70ac/64
 - Primary DNS Address :
 - Secondary DNS Address :
 - DHCP-PD : Enabled
 - IPv6 Network assigned by DHCP-PD :
- LAN IPv6 Computers:** A table with two columns: 'IPv6 Address' and 'Name (if any)'. The table is currently empty.
- Helpful Hints ...:** A sidebar note stating, 'All of your IPv6 LAN connection details are displayed here.' with a 'More...' link.

IPv6 Routing

This page displays the IPv6 routing details configured for your router.

The screenshot shows the D-Link web interface for the DIR-826L router. The top navigation bar includes tabs for SETUP, ADVANCED, TOOLS, STATUS, and SUPPORT. The left sidebar contains a menu with options: DEVICE INFO, LOGS, STATISTICS, INTERNET SESSIONS, ROUTING, WIRELESS, IPV6, and IPv6 Routing. The main content area is titled 'IPv6 ROUTING' and contains the following text:

IPv6 Routing Table

This page displays the routing details configured for your router.

IPv6 ROUTING TABLE

Destination IP	Gateway	Metric	Interface
----------------	---------	--------	-----------

The table is currently empty. At the bottom left of the interface, the word 'WIRELESS' is displayed.

Support

The screenshot displays the D-Link DIR-826L web interface. At the top, the D-Link logo is visible. Below it, a navigation bar contains tabs for SETUP, ADVANCED, TOOLS, STATUS, and SUPPORT. The SUPPORT tab is selected. On the left side, a vertical menu lists the main sections: MENU, SETUP, ADVANCED, TOOLS, and STATUS. The main content area is divided into four sections:

- SUPPORT MENU**
 - [Setup](#)
 - [Advanced](#)
 - [Tools](#)
 - [Status](#)
 - [mydlink Settings](#)
- SETUP HELP**
 - [Internet Connection](#)
 - [WAN](#)
 - [Wireless](#)
 - [Network Settings](#)
 - [STORAGE](#)
 - [IPv6](#)
- ADVANCED HELP**
 - [Virtual Server](#)
 - [Port Forwarding](#)
 - [Application Rules](#)
 - [QoS Engine](#)
 - [Network Filter](#)
 - [Access Control](#)
 - [Website Filter](#)
 - [Inbound Filter](#)
 - [Firewall Settings](#)
 - [Routing](#)
 - [Advanced Wireless](#)
 - [Wi-Fi Protected Setup](#)
 - [Advanced Network](#)
 - [GUEST ZONE](#)
 - [IPv6 FIREWALL RULES](#)
 - [IPv6 Routing](#)
- TOOLS HELP**
 - [Admin](#)
 - [Time](#)
 - [Syslog](#)
 - [Email Settings](#)
 - [System](#)
 - [Firmware](#)
 - [Dynamic DNS](#)
 - [System Check](#)
 - [Schedules](#)
- STATUS HELP**
 - [Device Info](#)
 - [Logs](#)
 - [Statistics](#)
 - [Internet Sessions](#)
 - [Wireless](#)
 - [IPv6](#)
 - [IPv6 Routing](#)

At the bottom left of the interface, the word "WIRELESS" is displayed.

Connect a Wireless Client to your Router

WPS Button

The easiest and most secure way to connect your wireless devices to the router is WPS (Wi-Fi Protected Setup). Most wireless devices such as wireless adapters, media players, Blu-ray DVD players, wireless printers and cameras will have a WPS button (or a software utility with WPS) that you can press to connect to the DIR-826L router. Please refer to your user manual for the wireless device you want to connect to make sure you understand how to enable WPS. Once you know, follow the steps below:

Step 1 - Press the WPS button on the DIR-826L for about 1 second. The Internet LED on the front will start to blink.



Step 2 - Within 2 minutes, press the WPS button on your wireless client (or launch the software utility and start the WPS process).

Step 3 - Allow up to 1 minute to configure. Once the Internet light stops blinking, you will be connected and your wireless connection will be secure with WPA2.

Windows® 7

WPA/WPA2

It is recommended to enable wireless security (WPA/WPA2) on your wireless router or access point before configuring your wireless adapter. If you are joining an existing network, you will need to know the security key or passphrase being used.

1. Click on the wireless icon in your system tray (lower-right corner).

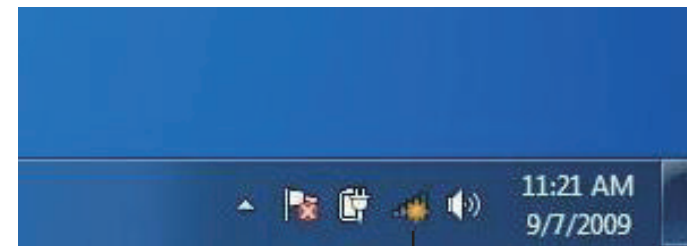

Wireless Icon

2. The utility will display any available wireless networks in your area.



3. Highlight the wireless connection with Wi-Fi name (SSID) you would like to connect to and click the **Connect** button.

If you get a good signal but cannot access the Internet, check your TCP/IP settings for your wireless adapter. Refer to the Networking Basics section in this manual for more information.



4. The following window appears while your computer tries to connect to the router.

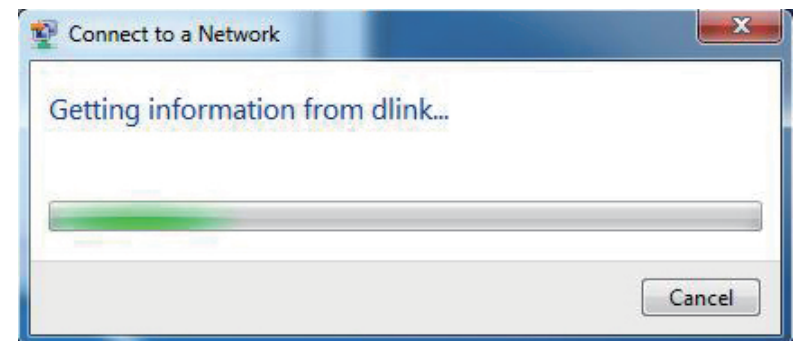

5. Enter the same security key or passphrase (Wi-Fi password) that is on your router and click **Connect**. You can also connect by pushing the WPS button on the router.

It may take 20-30 seconds to connect to the wireless network. If the connection fails, please verify that the security settings are correct. The key or passphrase must be exactly the same as on the wireless router.

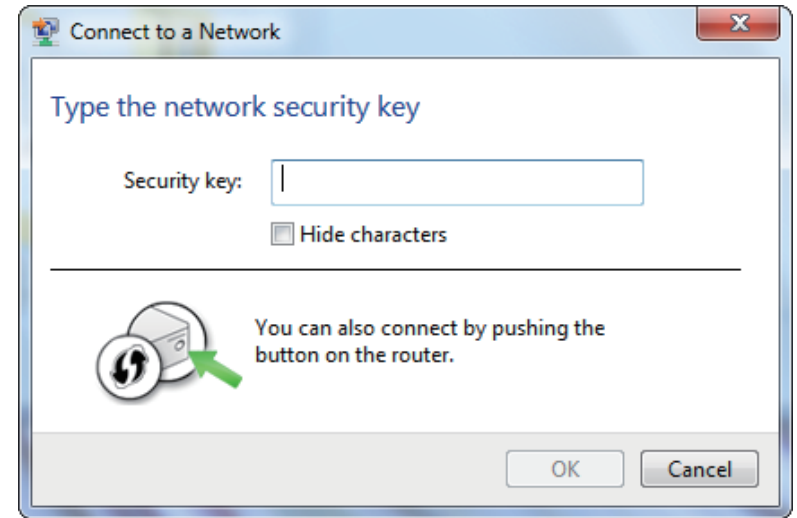

WPS

The WPS feature of the DIR-826L can be configured using Windows® 7. Carry out the following steps to use Windows® 7 to configure the WPS feature:

1. Click the **Start** button and select **Computer** from the Start menu.

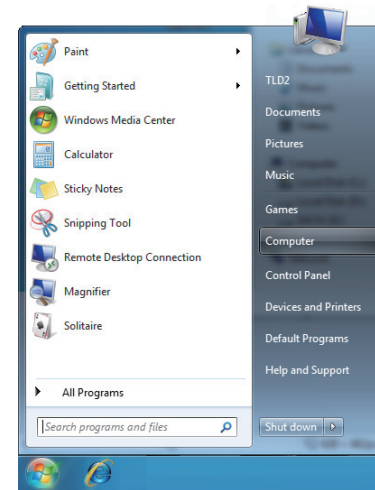

2. Click **Network** on the left side.

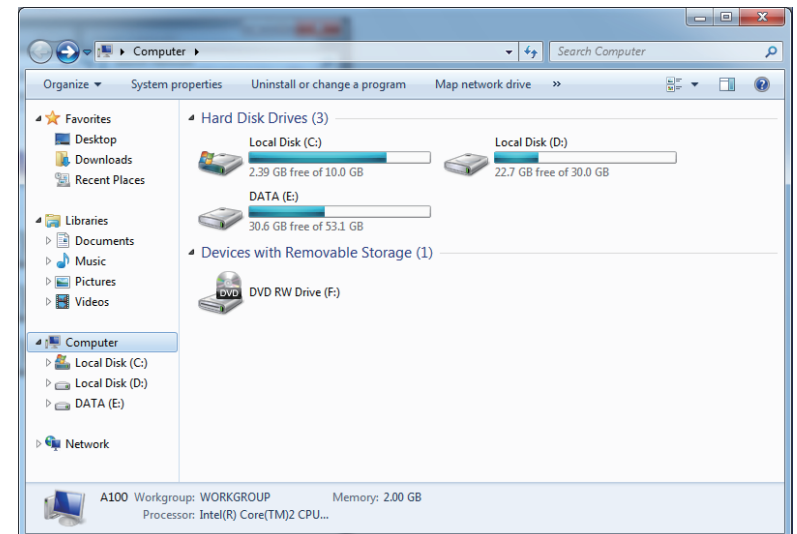

3. Double-click the DIR-826L.

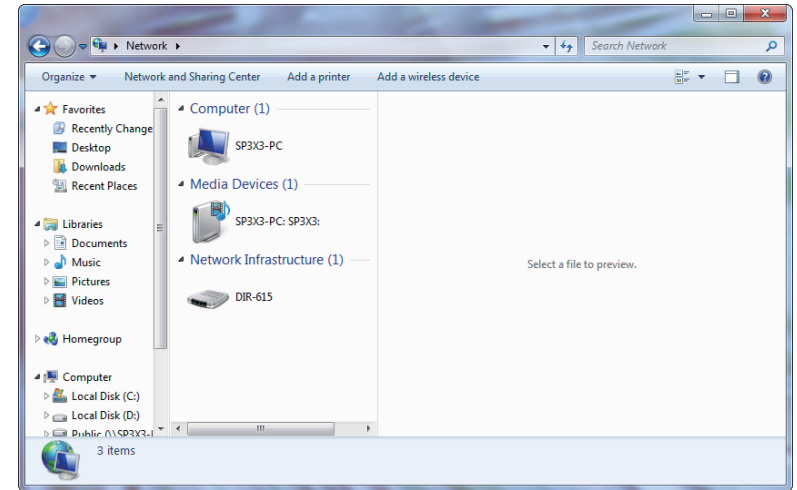

4. Input the WPS PIN number (displayed in the WPS window on the Router's LCD screen or in the **Setup** > **Wireless Setup** menu in the Router's Web UI) and click **Next**.

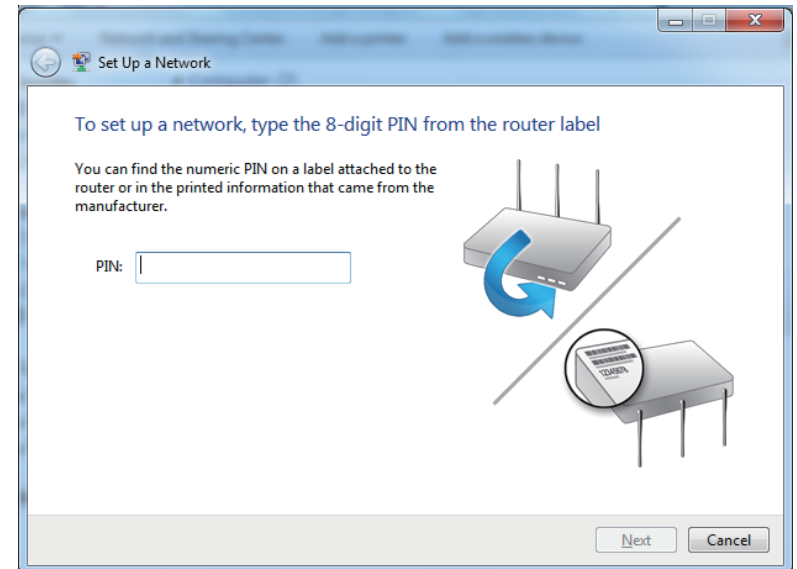

5. Type a name to identify the network.

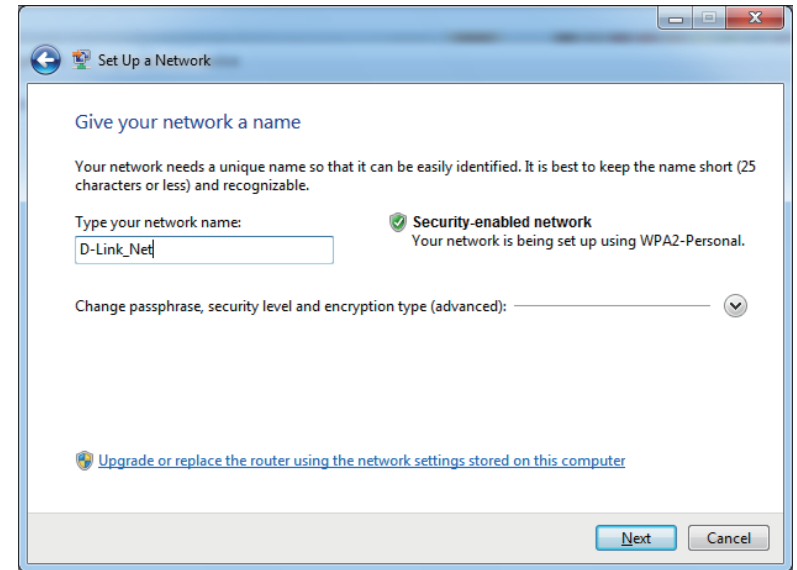

6. To configure advanced settings, click the  icon.

Click **Next** to continue.

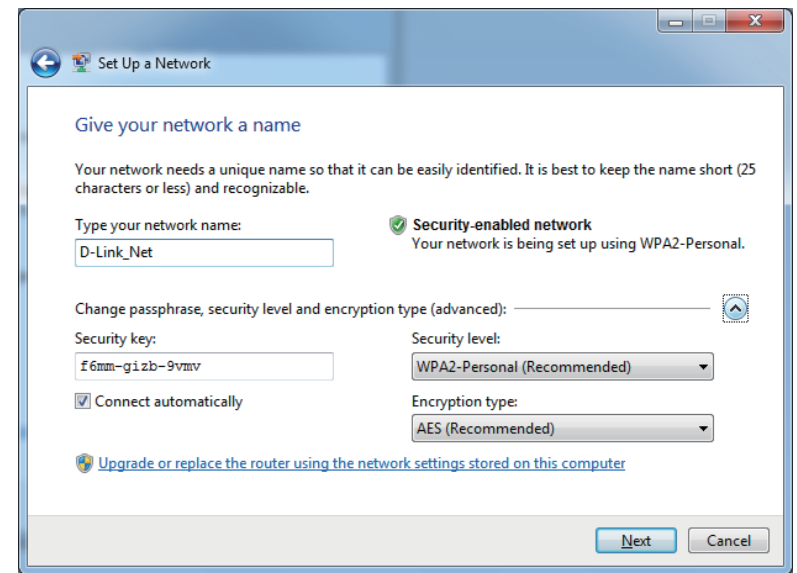

7. The following window appears while the Router is being configured.

Wait for the configuration to complete.

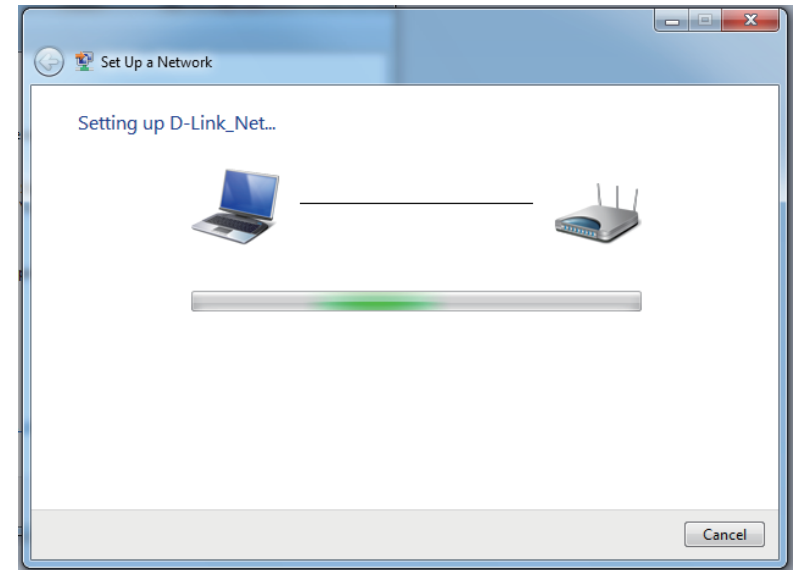

8. The following window informs you that WPS on the router has been setup successfully.

Make a note of the security key as you may need to provide this security key if adding an older wireless device to the network in the future.

9. Click **Close** to complete WPS setup.

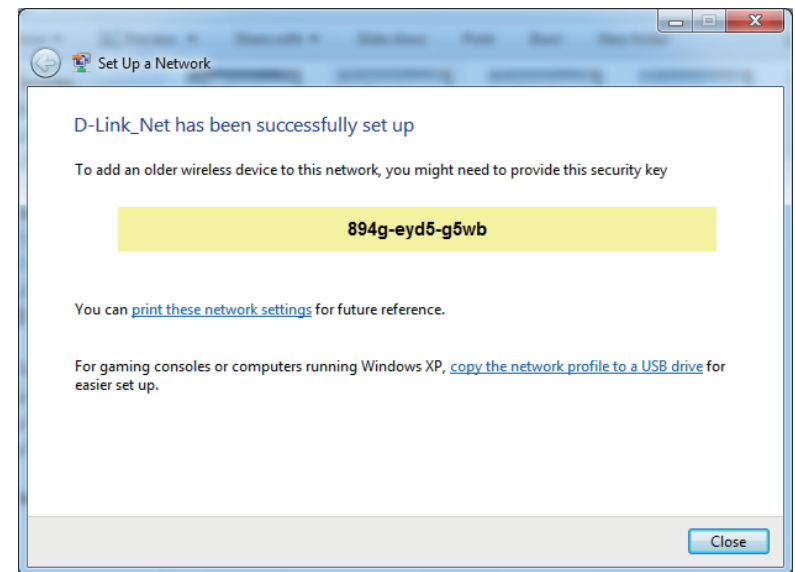

Windows Vista®

Windows Vista® users may use the built-in wireless utility. If you are using another company's utility, please refer to the user manual of your wireless adapter for help with connecting to a wireless network. Most utilities will have a "site survey" option similar to the Windows Vista® utility as seen below.

If you receive the **Wireless Networks Detected** bubble, click on the center of the bubble to access the utility.

or

Right-click on the wireless computer icon in your system tray (lower-right corner next to the time). Select **Connect to a network**.

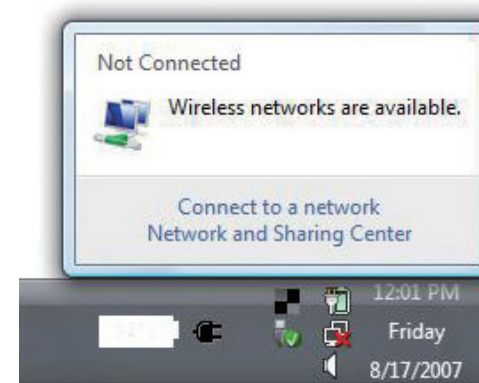

The utility will display any available wireless networks in your area. Click on a network (displayed using the SSID) and click the **Connect** button.

If you get a good signal but cannot access the Internet, check you TCP/IP settings for your wireless adapter. Refer to the **Networking Basics** section in this manual for more information.

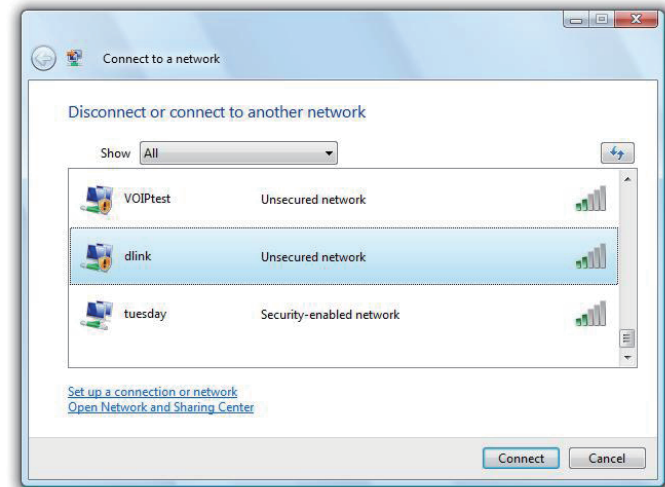

WPA/WPA2

It is recommended to enable wireless security (WPA/WPA2) on your wireless router or access point before configuring your wireless adapter. If you are joining an existing network, you will need to know the security key or passphrase being used.

1. Open the Windows Vista® Wireless Utility by right-clicking on the wireless computer icon in your system tray (lower right corner of screen). Select **Connect to a network**.
2. Highlight the Wi-Fi name (SSID) you would like to connect to and click **Connect**.

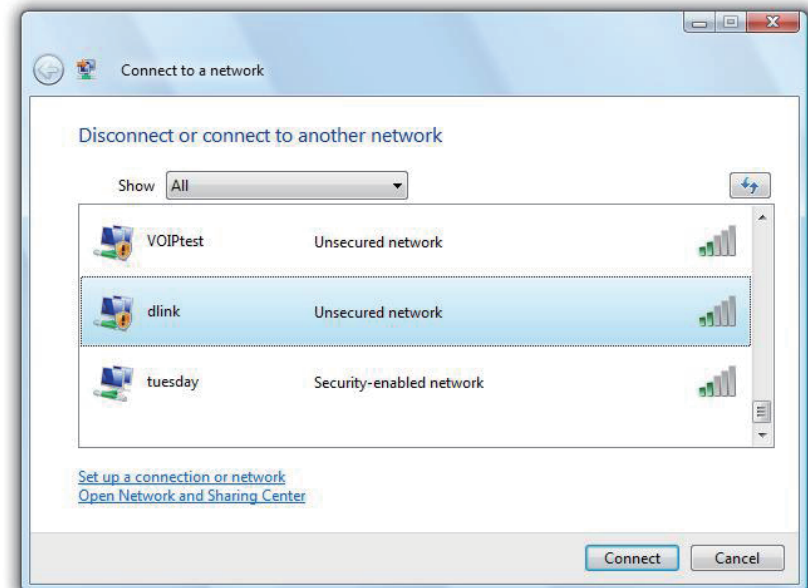
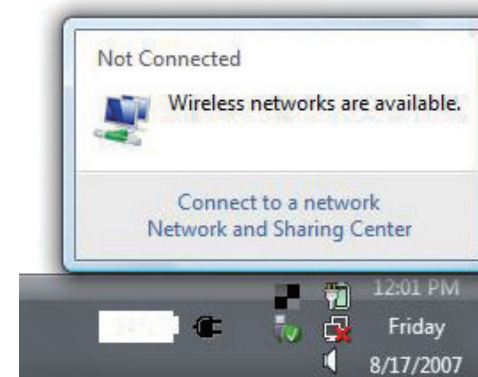

3. Enter the same security key or passphrase (Wi-Fi password) that is on your router and click **Connect**.

It may take 20-30 seconds to connect to the wireless network. If the connection fails, please verify that the security settings are correct. The key or passphrase must be exactly the same as on the wireless router.

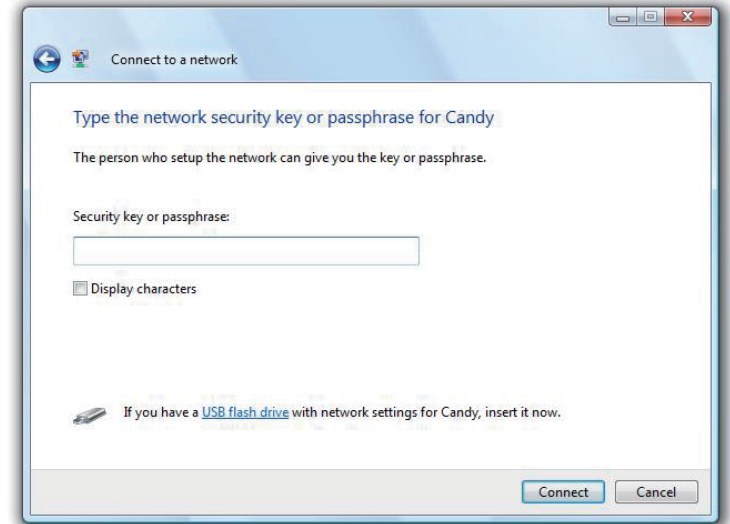

WPS/WCN 2.0

The router supports Wi-Fi protection, referred to as WCN 2.0 in Windows Vista®. The following instructions for setting this up depends on whether you are using Windows Vista® to configure the router or third party software.

When you first set up the router, Wi-Fi protection is disabled and unconfigured. To enjoy the benefits of Wi-Fi protection, the router must be both enabled and configured. There are three basic methods to accomplish this: use Windows Vista's built-in support for WCN 2.0, use software provided by a third party, or manually configure.

If you are running Windows Vista®, log into the router and click the **Enable** checkbox in the **Basic > Wireless** section. Use the Current PIN that is displayed on the **Advanced > Wi-Fi Protected Setup** section or choose to click the **Generate New PIN** button or **Reset PIN to Default** button.

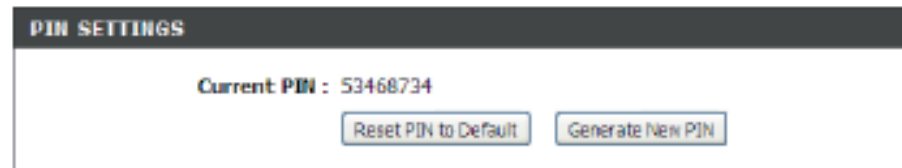

If you are using third party software to set up Wi-Fi Protection, carefully follow the directions. When you are finished, proceed to the next section to set up the newly-configured router.

Windows® XP

Windows® XP users may use the built-in wireless utility (Zero Configuration Utility). The following instructions are for Service Pack 2 users. If you are using another company's utility, please refer to the user manual of your wireless adapter for help with connecting to a wireless network. Most utilities will have a "site survey" option similar to the Windows® XP utility as seen below.

If you receive the **Wireless Networks Detected** bubble, click on the center of the bubble to access the utility.

or

Right-click on the wireless computer icon in your system tray (lower-right corner next to the time). Select **View Available Wireless Networks**.

The utility will display any available wireless networks in your area. Click on a Wi-Fi network (displayed using the SSID) and click the **Connect** button.

If you get a good signal but cannot access the Internet, check you TCP/IP settings for your wireless adapter. Refer to the **Networking Basics** section in this manual for more information.

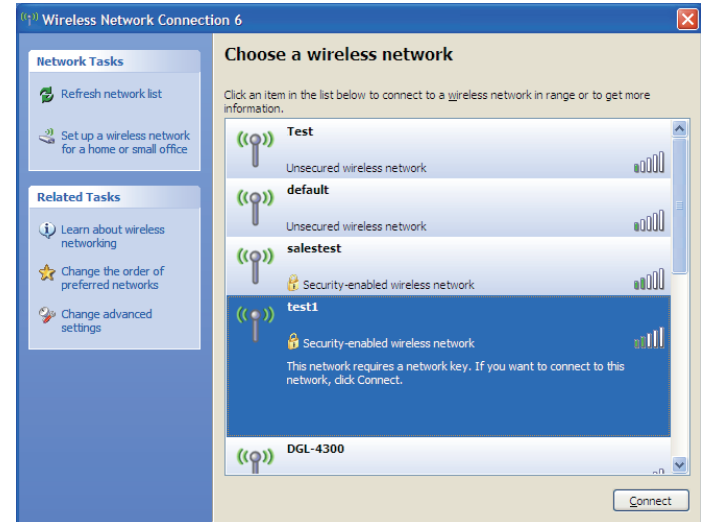
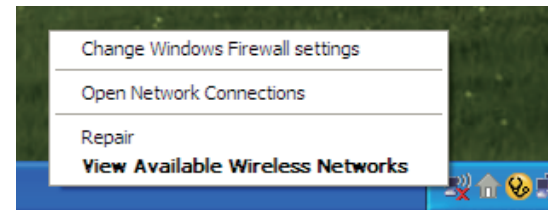
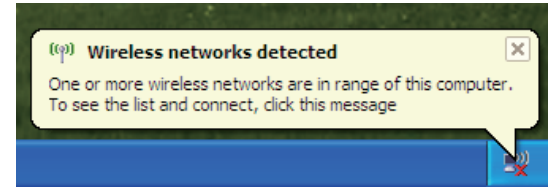

WPA/WPA2

It is recommended to enable WPA on your wireless router or access point before configuring your wireless adapter. If you are joining an existing network, you will need to know the WPA key being used.

1. Open the Windows® XP Wireless Utility by right-clicking on the wireless computer icon in your system tray (lower-right corner of screen). Select **View Available Wireless Networks**.
2. Highlight the Wi-Fi network (SSID) you would like to connect to and click **Connect**.

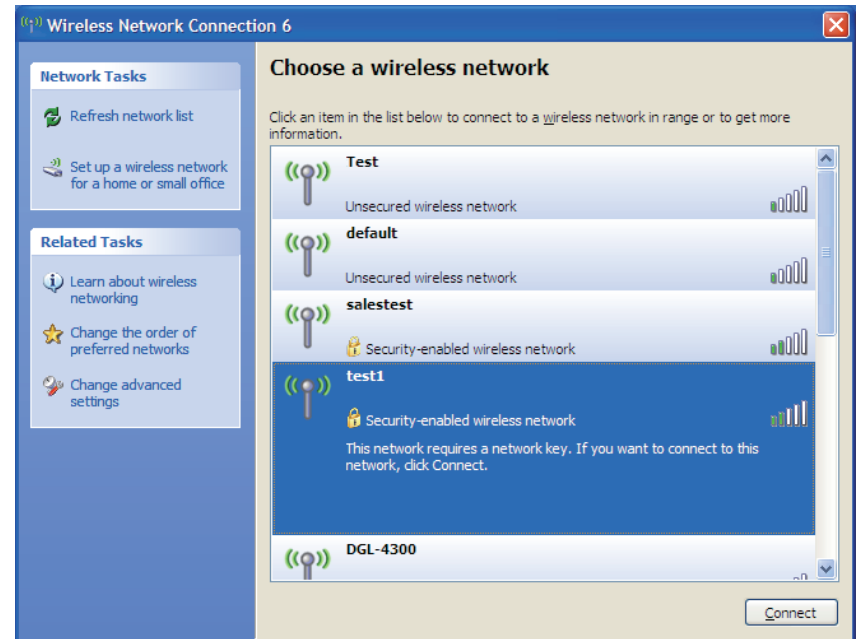
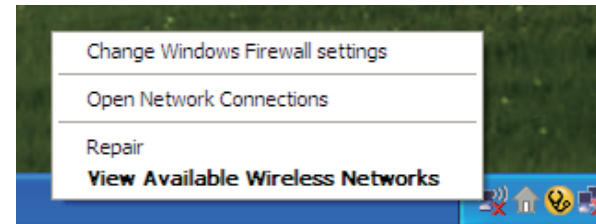

3. The **Wireless Network Connection** box will appear. Enter the WPA-PSK Wi-Fi password and click **Connect**.

It may take 20-30 seconds to connect to the wireless network. If the connection fails, please verify that the WPA-PSK settings are correct. The Wi-Fi password must be exactly the same as on the wireless router.

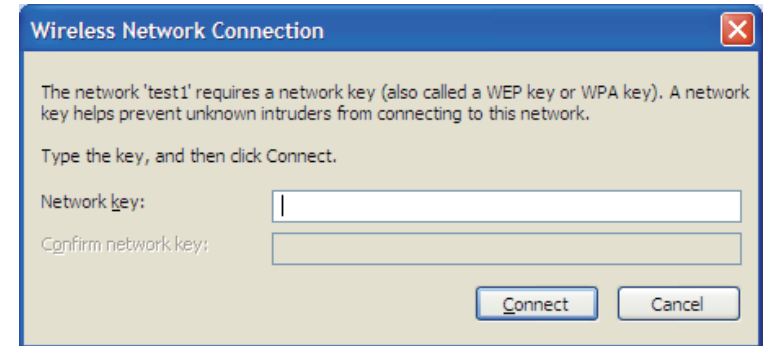

Troubleshooting

This chapter provides solutions to problems that can occur during the installation and operation of the DIR-826L. Read the following descriptions if you are having problems. The examples below are illustrated in Windows® XP. If you have a different operating system, the screenshots on your computer will look similar to the following examples.

1. Why can't I access the web-based configuration utility?

When entering the IP address of the D-Link router (192.168.0.1 for example), you are not connecting to a website nor do you have to be connected to the Internet. The device has the utility built-in to a ROM chip in the device itself. Your computer must be on the same IP subnet to connect to the web-based utility.

- Make sure you have an updated Java-enabled web browser. We recommend the following:
 - Microsoft Internet Explorer® 7 and higher
 - Mozilla Firefox 3.5 and higher
 - Google™ Chrome 8 and higher
 - Apple Safari 4 and higher
- Verify physical connectivity by checking for solid link lights on the device. If you do not get a solid link light, try using a different cable or connect to a different port on the device if possible. If the computer is turned off, the link light may not be on.
- Disable any Internet security software running on the computer. Software firewalls such as Zone Alarm, Black Ice, Sygate, Norton Personal Firewall, and Windows® XP firewall may block access to the configuration pages. Check the help files included with your firewall software for more information on disabling or configuring it.

- Configure your Internet settings:
 - Go to **Start > Settings > Control Panel**. Double-click the **Internet Options** icon. From the **Security** tab, click the button to restore the settings to their defaults.
 - Click the **Connection** tab and set the dial-up option to Never Dial a Connection. Click the LAN Settings button. Make sure nothing is checked. Click **OK**.
 - Go to the **Advanced** tab and click the button to restore these settings to their defaults. Click **OK** three times.
 - Close your web browser (if open) and open it.
- Access the web management. Open your web browser and enter the IP address of your D-Link router in the address bar. This should open the login page for your web management.
- If you still cannot access the configuration, unplug the power to the router for 10 seconds and plug back in. Wait about 30 seconds and try accessing the configuration. If you have multiple computers, try connecting using a different computer.

2. What can I do if I forgot my password?

If you forgot your password, you must reset your router. Unfortunately this process will change all your settings back to the factory defaults.

To reset the router, locate the reset button (hole) on the rear panel of the unit. With the router powered on, use a paperclip to hold the button down for 10 seconds. Release the button and the router will go through its reboot process. Wait about 30 seconds to access the router. The default IP address is 192.168.0.1. When logging in, the username is **admin** and leave the password box empty.

3. Why can't I connect to certain sites or send and receive emails when connecting through my router?

If you are having a problem sending or receiving email, or connecting to secure sites such as eBay, banking sites, and Hotmail, we suggest lowering the MTU in increments of ten (Ex. 1492, 1482, 1472, etc).

To find the proper MTU Size, you'll have to do a special ping of the destination you're trying to go to. A destination could be another computer, or a URL.

- Click on **Start** and then click **Run**.
- Windows® 95, 98, and Me users type in **command** (Windows® NT, 2000, XP, Vista®, and 7 users type in **cmd**) and press **Enter** (or click **OK**).
- Once the window opens, you'll need to do a special ping. Use the following syntax:

ping [url] [-f] [-l] [MTU value]

Example: **ping yahoo.com -f -l 1472**

```
C:\>ping yahoo.com -f -l 1482
Pinging yahoo.com [66.94.234.13] with 1482 bytes of data:
Packet needs to be fragmented but DF set.
Packet needs to be fragmented but DF set.
Packet needs to be fragmented but DF set.
Packet needs to be fragmented but DF set.
Ping statistics for 66.94.234.13:
    Packets: Sent = 4, Received = 0, Lost = 4 (100% loss),
    Approximate round trip times in milli-seconds:
        Minimum = 0ms, Maximum = 0ms, Average = 0ms
C:\>ping yahoo.com -f -l 1472
Pinging yahoo.com [66.94.234.13] with 1472 bytes of data:
Reply from 66.94.234.13: bytes=1472 time=93ms TTL=52
Reply from 66.94.234.13: bytes=1472 time=109ms TTL=52
Reply from 66.94.234.13: bytes=1472 time=125ms TTL=52
Reply from 66.94.234.13: bytes=1472 time=203ms TTL=52
Ping statistics for 66.94.234.13:
    Packets: Sent = 4, Received = 4, Lost = 0 (0% loss),
    Approximate round trip times in milli-seconds:
        Minimum = 93ms, Maximum = 203ms, Average = 132ms
C:\>
```

You should start at 1472 and work your way down by 10 each time. Once you get a reply, go up by 2 until you get a fragmented packet. Take that value and add 28 to the value to account for the various TCP/IP headers. For example, let's say that 1452 was the proper value, the actual MTU size would be 1480, which is the optimum for the network we're working with (1452+28=1480).

Once you find your MTU, you can now configure your router with the proper MTU size.

To change the MTU rate on your router follow the steps below:

- Open your browser, enter the IP address of your router (192.168.0.1) and click **OK**.
- Enter your username (admin) and password (blank by default). Click **OK** to enter the web configuration page for the device.
- Click on **Setup** and then click **Manual Configure**.
- To change the MTU enter the number in the MTU field and click **Save Settings** to save your settings.
- Test your email. If changing the MTU does not resolve the problem, continue changing the MTU in increments of ten.

Wireless Basics

D-Link wireless products are based on industry standards to provide easy-to-use and compatible high-speed wireless connectivity within your home, business or public access wireless networks. Strictly adhering to the IEEE standard, the D-Link wireless family of products will allow you to securely access the data you want, when and where you want it. You will be able to enjoy the freedom that wireless networking delivers.

A wireless local area network (WLAN) is a cellular computer network that transmits and receives data with radio signals instead of wires. Wireless LANs are used increasingly in both home and office environments, and public areas such as airports, coffee shops and universities. Innovative ways to utilize WLAN technology are helping people to work and communicate more efficiently. Increased mobility and the absence of cabling and other fixed infrastructure have proven to be beneficial for many users.

Wireless users can use the same applications they use on a wired network. Wireless adapter cards used on laptop and desktop systems support the same protocols as Ethernet adapter cards.

Under many circumstances, it may be desirable for mobile network devices to link to a conventional Ethernet LAN in order to use servers, printers or an Internet connection supplied through the wired LAN. A Wireless Router is a device used to provide this link.

What is Wireless?

Wireless or Wi-Fi technology is another way of connecting your computer to the network without using wires. Wi-Fi uses radio frequency to connect wirelessly, so you have the freedom to connect computers anywhere in your home or office network.

Why D-Link Wireless?

D-Link is the worldwide leader and award winning designer, developer, and manufacturer of networking products. D-Link delivers the performance you need at a price you can afford. D-Link has all the products you need to build your network.

How does wireless work?

Wireless works similar to how cordless phone work, through radio signals to transmit data from one point A to point B. But wireless technology has restrictions as to how you can access the network. You must be within the wireless network range area to be able to connect your computer. There are two different types of wireless networks Wireless Local Area Network (WLAN), and Wireless Personal Area Network (WPAN).

Wireless Local Area Network (WLAN)

In a wireless local area network, a device called an Access Point (AP) connects computers to the network. The access point has a small antenna attached to it, which allows it to transmit data back and forth over radio signals. With an indoor access point as seen in the picture, the signal can travel up to 300 feet. With an outdoor access point the signal can reach out up to 30 miles to serve places like manufacturing plants, industrial locations, college and high school campuses, airports, golf courses, and many other outdoor venues.

Wireless Personal Area Network (WPAN)

Bluetooth is the industry standard wireless technology used for WPAN. Bluetooth devices in WPAN operate in a range up to 30 feet away.

Compared to WLAN the speed and wireless operation range are both less than WLAN, but in return it doesn't use nearly as much power which makes it ideal for personal devices, such as mobile phones, PDAs, headphones, laptops, speakers, and other devices that operate on batteries.

Who uses wireless?

Wireless technology has become so popular in recent years that almost everyone is using it, whether it's for home, office, business, D-Link has a wireless solution for it.

Home

- Gives everyone at home broadband access
- Surf the web, check email, instant message, etc.
- Gets rid of the cables around the house
- Simple and easy to use

Small Office and Home Office

- Stay on top of everything at home as you would at office
- Remotely access your office network from home
- Share Internet connection and printer with multiple computers
- No need to dedicate office space

Where is wireless used?

Wireless technology is expanding everywhere not just at home or office. People like the freedom of mobility and it's becoming so popular that more and more public facilities now provide wireless access to attract people. The wireless connection in public places is usually called "hotspots".

Using a D-Link Cardbus Adapter with your laptop, you can access the hotspot to connect to Internet from remote locations like: Airports, Hotels, Coffee Shops, Libraries, Restaurants, and Convention Centers.

Wireless network is easy to setup, but if you're installing it for the first time it could be quite a task not knowing where to start. That's why we've put together a few setup steps and tips to help you through the process of setting up a wireless network.

Tips

Here are a few things to keep in mind, when you install a wireless network.

Centralize your router or Access Point

Make sure you place the router/access point in a centralized location within your network for the best performance. Try to place the router/access point as high as possible in the room, so the signal gets dispersed throughout your home. If you have a two-story home, you may need a repeater to boost the signal to extend the range.

Eliminate Interference

Place home appliances such as cordless telephones, microwaves, and televisions as far away as possible from the router/access point. This would significantly reduce any interference that the appliances might cause since they operate on same frequency.

Security

Don't let your next-door neighbors or intruders connect to your wireless network. Secure your wireless network by turning on the WPA or WEP security feature on the router. Refer to product manual for detail information on how to set it up.

Wireless Modes

There are basically two modes of networking:

- **Infrastructure** – All wireless clients will connect to an access point or wireless router.
- **Ad-Hoc** – Directly connecting to another computer, for peer-to-peer communication, using wireless network adapters on each computer, such as two or more DIR-826L wireless network Cardbus adapters.

An Infrastructure network contains an Access Point or wireless router. All the wireless devices, or clients, will connect to the wireless router or access point.

An Ad-Hoc network contains only clients, such as laptops with wireless cardbus adapters. All the adapters must be in Ad-Hoc mode to communicate.

Networking Basics

Check your IP address

After you install your new D-Link adapter, by default, the TCP/IP settings should be set to obtain an IP address from a DHCP server (i.e. wireless router) automatically. To verify your IP address, please follow the steps below.

Click on **Start > Run**. In the run box type **cmd** and click **OK**. (Windows® 7/Vista® users type **cmd** in the **Start Search** box.)

At the prompt, type **ipconfig** and press **Enter**.

This will display the IP address, subnet mask, and the default gateway of your adapter.

If the address is 0.0.0.0, check your adapter installation, security settings, and the settings on your router. Some firewall software programs may block a DHCP request on newly installed adapters.

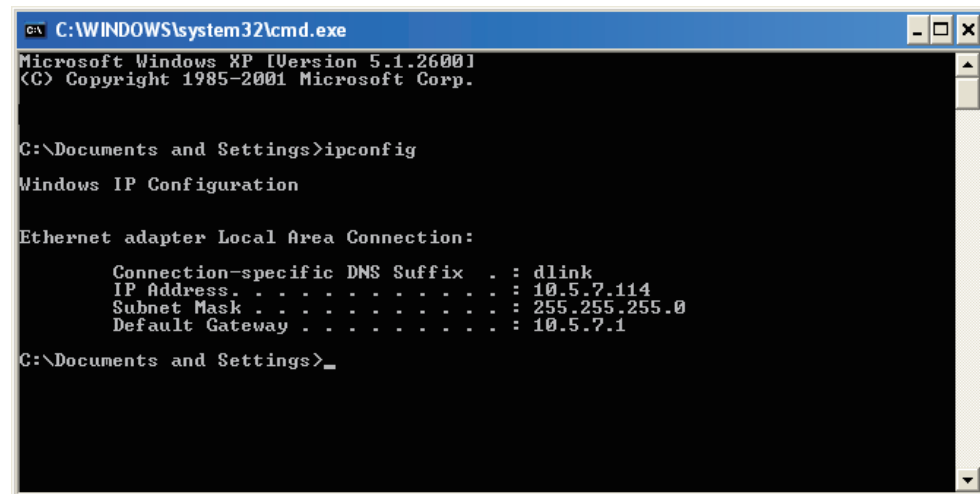

```
C:\WINDOWS\system32\cmd.exe
Microsoft Windows XP [Version 5.1.2600]
(C) Copyright 1985-2001 Microsoft Corp.

C:\Documents and Settings>ipconfig

Windows IP Configuration

Ethernet adapter Local Area Connection:

    Connection-specific DNS Suffix  . : dlink
    IP Address . . . . . : 10.5.7.114
    Subnet Mask . . . . . : 255.255.255.0
    Default Gateway . . . . . : 10.5.7.1

C:\Documents and Settings>_
```

Statically Assign an IP address

If you are not using a DHCP capable gateway/router, or you need to assign a static IP address, please follow the steps below:

- Step 1**
- Windows® 7 - Click on **Start > Control Panel > Network and Internet > Network and Sharing Center.**
 - Windows Vista® - Click on **Start > Control Panel > Network and Internet > Network and Sharing Center > Manage Network Connections.**
 - Windows® XP - Click on **Start > Control Panel > Network Connections.**
 - Windows® 2000 - From the desktop, right-click **My Network Places > Properties.**

Step 2
Right-click on the **Local Area Connection** which represents your network adapter and select **Properties.**

Step 3
Highlight **Internet Protocol (TCP/IP)** and click **Properties.**

Step 4
Click **Use the following IP address** and enter an IP address that is on the same subnet as your network or the LAN IP address on your router.

Example: If the router's LAN IP address is 192.168.0.1, make your IP address 192.168.0.X where X is a number between 2 and 99. Make sure that the number you choose is not in use on the network. Set the Default Gateway the same as the LAN IP address of your router (I.E. 192.168.0.1).

Set Primary DNS the same as the LAN IP address of your router (192.168.0.1). The Secondary DNS is not needed or you may enter a DNS server from your ISP.

Step 5
Click **OK** twice to save your settings.

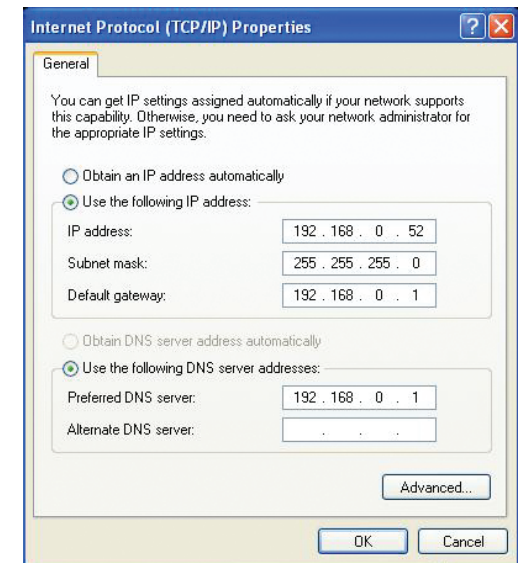

Technical Specifications

Standards

- IEEE 802.11n
- IEEE 802.11g
- IEEE 802.11a
- IEEE 802.3
- IEEE 802.3u
- IEEE 802.3ab

Security

- WPA™ - Personal/Enterprise
- WPA2™ - Personal/Enterprise

Wireless Signal Rates¹

IEEE 802.11n 2.4GHz(HT20/40):

- 144.4Mbps (300)
- 115.6Mbps (240)
- 72.2Mbps (150)
- 57.8Mbps (120)
- 28.9Mbps (60)
- 14.4Mbps (30)
- 130Mbps (270)
- 86.7Mbps (180)
- 65Mbps (135)
- 43.3Mbps (90)
- 21.7Mbps (45)
- 7.2Mbps (15)

IEEE 802.11n 5GHz(HT20/40):

- 144.4Mbps (300)
- 115.6Mbps (240)
- 72.2Mbps (150)
- 57.8Mbps (120)
- 28.9Mbps (60)
- 14.4Mbps (30)
- 130Mbps (270)
- 86.7Mbps (180)
- 65Mbps (135)
- 43.3Mbps (90)
- 21.7Mbps (45)
- 7.2Mbps (15)

IEEE 802.11g:

- 54Mbps
- 24Mbps
- 11Mbps
- 5.5Mbps
- 48Mbps
- 18Mbps
- 9Mbps
- 2Mbps
- 36Mbps
- 12Mbps
- 6Mbps
- 1Mbps

Frequency Range²

- 2.412GHz to 2.462GHz (802.11g/n)
- 5.15GHz to 5.825GHz (802.11a/n)³
- 2.4GHz to 2.483GHz
- 5.15GHz to 5.35GHz
- 5.47GHz to 5.725GHz

Operating Temperature

- 32°F to 104°F (0°C to 40°C)

Humidity

- 95% maximum (non-condensing)

Safety & Emissions

- FCC
- IC
- CE
- C-Tick
- UL

Dimensions

- L = 11.1 cm
- W = 9.3 cm
- H = 14.5 cm

¹ Maximum wireless signal rate derived from IEEE Standard 802.11a, 802.11g, and 802.11n specifications. Actual data throughput will vary. Network conditions and environmental factors, including volume of network traffic, building materials and construction, and network overhead, lower actual data throughput rate. Environmental factors will adversely affect wireless signal range.

² Frequency Range varies depending on country's regulation

³ The DIR-826L does not include 5.25-5.35GHz & 5.47-5.725GHz in some regions.

Trademarks:

D-Link is a registered trademark of D-Link Corporation/D-Link Systems, Inc. Other trademarks or registered trademarks are the property of their respective owners.

Copyright Statement:

No part of this publication or documentation accompanying this product may be reproduced in any form or by any means or used to make any derivative such as translation, transformation, or adaptation without permission from D-Link Corporation/D-Link Systems, Inc., as stipulated by the United States Copyright Act of 1976 and any amendments thereto. Contents are subject to change without prior notice.

Copyright ©2012 by D-Link Corporation/D-Link Systems, Inc. All rights reserved.

CE Mark Warning:

This is a Class B product. In a domestic environment, this product may cause radio interference, in which case the user may be required to take adequate measures.

FCC Statement:

This equipment has been tested and found to comply with the limits for a Class B digital device, pursuant to Part 15 of the FCC Rules. These limits are designed to provide reasonable protection against harmful interference in a residential installation. This equipment generates, uses and can radiate radio frequency energy and, if not installed and used in accordance with the instructions, may cause harmful interference to radio communications. However, there is no guarantee that interference will not occur in a particular installation. If this equipment does cause harmful interference to radio or television reception, which can be determined by turning the equipment off and on, the user is encouraged to try to correct the interference by one of the following measures:

- Reorient or relocate the receiving antenna.
- Increase the separation between the equipment and receiver.
- Connect the equipment into an outlet on a circuit different from that to which the receiver is connected.
- Consult the dealer or an experienced radio/TV technician for help.

This device complies with Part 15 of the FCC Rules. Operation is subject to the following two conditions: (1) This device may not cause harmful interference, and (2) this device must accept any interference received, including interference that may cause undesired operation.

FCC Caution:

Any changes or modifications not expressly approved by the party responsible for compliance could void the user's authority to operate this equipment.

Operations in the 5.15-5.25GHz / 5.470 ~ 5.725GHz band are restricted to indoor usage only.

IMPORTANT NOTICE:**FCC Radiation Exposure Statement:**

This equipment complies with FCC radiation exposure limits set forth for an uncontrolled environment. This equipment should be installed and operated with minimum distance 20cm between the radiator & your body. To maintain compliance with FCC RF exposure compliance requirements, please avoid direct contact to the transmitting antenna during transmitting.

If this device is going to be operated in 5.15 ~ 5.25GHz frequency range, then it is restricted in indoor environment only. This transmitter must not be co-located or operating in conjunction with any other antenna or transmitter.

The availability of some specific channels and/or operational frequency bands are country dependent and are firmware programmed at the factory to match the intended destination. The firmware setting is not accessible by the end user.

ICC Notice:

Operation is subject to the following two conditions:

- 1) This device may not cause interference and
- 2) This device must accept any interference, including interference that may cause undesired operation of the device.

IMPORTANT NOTE:**IC Radiation Exposure Statement:**

This equipment complies with IC radiation exposure limits set forth for an uncontrolled environment. End users must follow the specific operating instructions for satisfying RF exposure compliance. This equipment should be installed and operated with minimum distance 20cm between the radiator & your body.

This transmitter must not be co-located or operating in conjunction with any other antenna or transmitter.

- (i) The device for the band 5150-5250 MHz is only for indoor usage to reduce potential for harmful interference to co-channel mobile satellite systems;
- (ii) The maximum antenna gain (2dBi) permitted (for devices in the band 5725-5825 MHz) to comply with the e.i.r.p. limits specified for point-to-point and non point-to-point operation as appropriate, as stated in section A9.2(3).

In addition, users should also be cautioned to take note that high-power radars are allocated as primary users (meaning they have priority) of the bands 5250-5350 MHz and 5650-5850 MHz and these radars could cause interference and/or damage to LE-LAN devices.

Règlement d'Industry Canada

Les conditions de fonctionnement sont sujettes à deux conditions:

- (1) Ce périphérique ne doit pas causer d'interférence et.
- (2) Ce périphérique doit accepter toute interférence, y compris les interférences pouvant perturber le bon fonctionnement de ce périphérique.